



**HANDHELD  
CAPNOGRAPH/OXIMETER**

**User's Manual**

**Model 710/715**

July 21, 2006

Catalog No. 9110-23-C

Copyright © 1998-2006, Respirationics, Inc. and its affiliates  
All rights reserved.



## **Revision History**

30-Oct-98 Release, Rev. 00  
15-Dec-98 Revision 01, R-N626  
27-Jan-99 Revision 02  
10-Dec-99 Revision 03, R-N719  
06-Apr-00 Revision 04, R-N746  
12-Oct-00 Revision 05, R-N835  
13-Mar-02 Revision 06, R-N1088  
01-Aug-05 Revision B, CO\_N2371  
21-Jul-06 Revision C, CO\_N3196

## **Respironics Hospital Division**

Respironics California, Inc.  
2271 Cosmos Court  
Carlsbad, CA USA 92011

Respironics Novamatrix, LLC  
5 Technology Drive  
Wallingford, CT U.S.A. 06492

## **Declaration of Conformity with European Union Directive**

The Authorized Representative for this equipment is:

Respironics Deutschland  
Gewerbestrasse 17  
82211 Herrsching  
Germany  
Tel: +49 8152 93060



## **Guarantee**

Equipment manufactured or distributed by Respironics, Inc. is fully guaranteed, covering materials and workmanship, for a period of one year from the date of shipment, except for certain disposable products and products with stated guarantees other than one year. Respironics reserves the right to perform guarantee service(s) at its factory, at an authorized repair station, or at the customer's installation.

Respironics' obligations under this guarantee are limited to repairs, or at Respironics' option, replacement of any defective parts of our equipment, except fuses, batteries, and calibration gasses, without charge, if said defects occur during normal service.

Claims for damages during shipment must be filed promptly with the transportation company. All correspondence concerning the equipment must specify both the model name and number, and the serial number as it appears on the equipment.

Improper use, mishandling, tampering with, or operation of the equipment without following specific operating instructions will void this guarantee and release Respiroics from any further guarantee obligations.

<p>Customer Service &amp; Product Support:</p> <p>USA and Canada Phone 1-800-345-6443 Customer Service Fax 1-800-886-0245 Product Support Fax 1-724-387-5236</p> <p>International Phone 724-387-4000 Fax 724-387-5012</p> <p>service@respiroics.com clinical@respiroics.com www.respiroics.com</p>
--

**Caution:** Federal (U.S.A.) law restricts this device to sale, distribution, or use by or on the order of a licensed medical practitioner.

Copyright © 2006, Respiroics, Inc. and its affiliates. This document contains information which is proprietary and the property of Respiroics and may not be reproduced, stored in a retrieval system, translated, transcribed, or transmitted, in any form, or by any means, without prior explicit written permission from Respiroics.

### ***Service Policy***

The Respiroics Hospital Services Group provides depot service for monitors and 24-hour a day access to technical support through its Technical Support Department in Murrysville, PA. (Outside the U.S., primary technical support is handled through our qualified international sales and service distributors.)

Contact the Technical Support Department by telephone toll free at 800-345-6443 ext 5; by facsimile at 724-387-5236; or by e-mail at service@respiroics.com for technical inquiries or clinical@respiroics.com for clinical inquiries. After hours telephone support requests (before 8:00 AM and after 5:00 PM Eastern Time) will be responded to promptly by the Technical Support on-call staff. After hours facsimile and e-mail requests will be answered the next business day. It is suggested that any person calling in for technical support have the equipment available for product identification and preliminary troubleshooting.

Respiroics reserves the right to repair or replace any product found to be defective during the warranty period. Repair may be provided in the form of replacement exchange parts or accessories, on-site technical repair assistance or complete system exchanges. Repairs provided due to product abuse or misuse will be considered "non-warranty" and invoiced at the prevailing service rate. Exchanged materials are expected to be returned to Respiroics within 10 days for full credit. Return materials should be cleaned as necessary and sent directly to Respiroics referencing the RA number provided. (Transferring return materials to a local sales or dealer representatives does not absolve you of your return responsibility.)

If the customer requires the return of their original product, the exchange material will be considered "loaner material" and exchanged again after the customer equipment is repaired.

Please contact Technical Support for information on these additional programs and services:

- Technical & Clinical Training
- Test Equipment and Test Kits
- Service Contract / Parts Insurance Plans
- On-Site Service Support

## ***Trademarks and Patents***

*TIDAL WAVE* and CAPNOSTAT are registered trademarks and Y-Sensor, SuperBright and OxySnap are trademarks of Respironics, Inc. Velcro is a registered trademark of Velcro USA, Inc. Cidex is a trademark of Arbook, Inc. Nafion is a registered trademark of Dow Corning Corp.

The *TIDAL WAVE*<sup>®</sup> *Sp* monitor and its sensors and accessories are covered by the following US patents: 4,859,858, 4,859,859, 4,914,720, 5,146,092, 5,153,436, 5,190,038, 5,206,511, 5,251,121, 5,369,277, 5,398,680, 5,448,991, 5,616,923, 5,693,944, 5,793,044, 5,820,550, 5,891,026, 5,999,834. Other patents pending.

[This page intentionally blank.]

# Contents

---

<b>General Description</b> .....	<b>1</b>
Indication for use .....	1
Keypanel Controls and Indicators .....	1
Connections and Labeling .....	4
Principle of operation .....	5
<b>Safety</b> .....	<b>7</b>
<b>Preparation for Use</b> .....	<b>11</b>
AC/Battery Operation .....	11
Battery Status and Alerts .....	11
Battery Use and Options .....	12
Configuration Menus .....	18
<b>Sensors and Patient Connections</b> .....	<b>23</b>
Adapter Types Available .....	23
Setting Adapter Type .....	23
Adapter Zero Procedure .....	24
CAPNOSTAT <sup>®</sup> CO <sub>2</sub> Sensor and Airway Adapter Setup .....	26
SpO <sub>2</sub> Sensors .....	29
<b>Monitoring</b> .....	<b>37</b>
Display of Data .....	37
Monitoring Mode .....	37
Screen Displays .....	38
Messages .....	40
Alerts .....	43
Setting Alert Limits .....	43
Alert Audio .....	45
Capnogram Sample Waveforms and Interpretations .....	46
Reference Handbooks .....	47
<b>RS232 Options</b> .....	<b>49</b>
Power and RS232 Serial Port Communications .....	49
<b>Maintenance</b> .....	<b>51</b>
Cleaning and Sterilization .....	51
Battery Maintenance .....	54
Maintenance Schedules .....	54
WEEE/RoHS Recycling Directives .....	54

<b>Specifications</b> .....	<b>55</b>
General .....	55
Capnograph .....	55
SpO <sub>2</sub> Section .....	56
Pulse Rate Section .....	57
Monitor Specifications .....	57
Additional Features .....	57
<b>Accessories</b> .....	<b>59</b>
<b>Electromagnetic Compatibility</b> .....	<b>61</b>
Warnings .....	61
Cautions .....	61
Electromagnetic Emissions .....	62
Electromagnetic Immunity .....	62



# Section 1

# General Description

## Indication for use

The Model 710 and Model 715 *TIDAL WAVE<sup>®</sup> Sp* handheld, portable Capnometer/Oximeters are intended to be used for monitoring end tidal CO<sub>2</sub>, respiration rate, functional oxygen saturation and pulse rate in monitoring environments such as ventilatory support, emergency and anesthesia. The Model 715 incorporates a miniature vacuum pump to draw expired respiratory gases through the CAPNOSTAT<sup>®</sup> CO<sub>2</sub> Sensor using a sampling airway adapter and nasal cannula. *TIDAL WAVE<sup>®</sup> Sp* is designed to monitor adult, pediatric and neonatal patients. *TIDAL WAVE<sup>®</sup> Sp* is not intended for any other purpose.

### NOTE

Components of this product and its associated accessories which have patient contact are free of latex.

## Keypanel Controls and Indicators

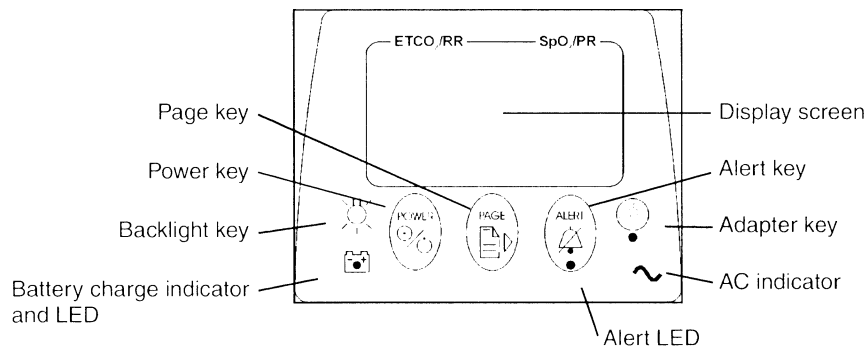

### Controls



#### Power Key

Switches power on/off. Press the POWER key to place the unit into operate mode (ON) or to turn the unit OFF. Refer to "AC/Battery Operation" on page 11.

With monitor ON, press and hold the POWER key to enter the MONITORING MODE selection menu. Refer to "Monitoring Mode" on page 37 for more information.



### **Page Key**

Press to set display screen to Data Display, EtCO<sub>2</sub> waveform, plethysmogram, EtCO<sub>2</sub> trend, Respiration trend or SpO<sub>2</sub> trend.



### **Alert Key**

Press to suspend audible alerts for 2 minutes and display the SET ALERTS menu. If the SET ALERTS menu is not needed, it will automatically disappear after 3 seconds.

For 2 minute suspend, the  icon will illuminate for the duration. Press again to cancel.

Press and hold for 3 seconds to disable audible alerts, and the  icon will flash. Press and hold again to cancel.

The Alert Key LED will display the following:

- Steady yellow: audio suspended for 2 min., no alert in progress.
- Flashing yellow: audio silenced (no alert in progress).
- Flashing red and yellow: alert in progress; audio is off or 2 minute suspend.

Audible alerts may be permanently disabled from the Configuration menu. Refer to “Configuration Menus” on page 18 for more information.



### **Adapter Key**

Press to set adapter type: adult, neonatal or sampling.

Press and hold for 4 seconds to zero an adapter. See “Adapter/Zero Procedure” on page 24 for more information.

Press to cancel Auto Power Off function.



### **Backlight Key**

Press to turn backlight on/off, or press and hold to adjust contrast for up/down viewing angles and for adjustment due to extreme temperature variations.

## **Indicators**



### **Battery Alert Indicator**

Illuminates when the unit is on battery power. Green: battery is fully charged, slow flashing yellow: battery power is low (approximately 20 minutes of operation remains), Fast flashing red: battery is exhausted (approximately 5 minutes of operation remains). The battery alert indicator is off when external power is connected. Refer to “AC/Battery Operation” on page 11 for information on connecting AC power and charging the battery.



### **AC Power Indicator**

Illuminated green when the monitor is connected to an AC power source (e.g. the external power supply (PN 9220-10), or the BaseStation (PN 6998-00), while powered by the external power supply).

**Icons**

The icons listed below may appear on the display screen when the *TIDAL WAVE<sup>®</sup> Sp* is in use.

**Alert Silence Icon**

Audible alerts silenced.

**2-Minute Suspend Icon**

Audible alert suspended for two minutes.

**Alert Limits Disabled Icon**

Alert limits disabled. Select ENABLED or DISABLED in the CONFIGURATION menu.

**Airway Adapter Icon**

Indicates adapter key.

**Time/Date Icon**

Set time/date. Press  from the CONFIGURATION menu to set time and date.

**Backlight Icon**

Indicates backlight key.

**Trend Screen Icon**

Displayed beside any Trend screen.

**Temperature Icon**

Sensor not up to temperature icon. Displayed when performing an adapter zero and the sensor is not at operating temperature.

**Waveform Icon**

CO<sub>2</sub> detected icon. Displayed when selecting an adapter zero and the monitor detects breaths.

**Heart Icon**

Pulse detected icon. Displayed when SpO<sub>2</sub> sensor is attached to patient and the monitor detects a pulse.







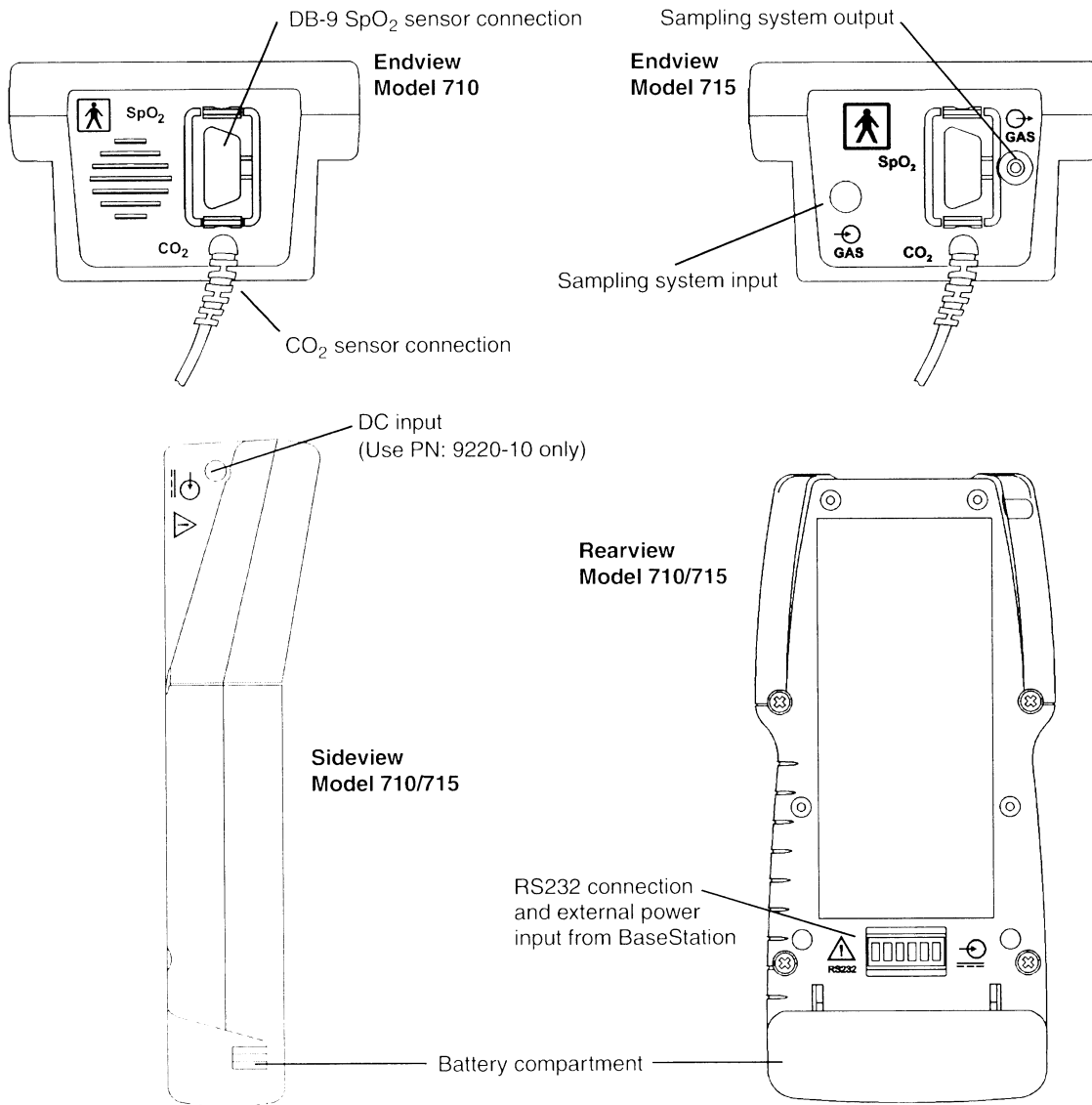

**Lung Icon**

Breaths detected icon. Displayed when CAPNOSTAT<sup>®</sup> CO<sub>2</sub> sensor is attached to patient and breaths are detected.

**Connections and Labeling**



## Symbols

	Patient isolation: Identifies connection as type BF.
	Attention: Consult manual for detailed information.
	Sampling System: Gas output
	Sampling System: Gas input
	DC input. Connect external power supply to this port. Use only Respiromics external power supply. Catalogue number 9220-10.
	Recyclable item. This symbol is found on the internal battery and should not concern the common user. Refer to qualified service personnel when battery replacement is required.
	Compliant with the WEEE/RoHS recycling directives. Separate collection. Appropriate steps must be taken to ensure that spent batteries are collected separately when disposed of.

## Principle of operation

### CO<sub>2</sub>

*TIDAL WAVE<sup>®</sup> Sp* uses the CAPNOSTAT<sup>™</sup> CO<sub>2</sub> sensor to measure CO<sub>2</sub> by using the infrared absorption technique, which has endured and evolved in the clinical setting for over two decades and remains the most popular and versatile technique today.

The principle is based on the fact that CO<sub>2</sub> molecules absorb infrared (IR) light energy of specific wavelengths, with the amount of energy absorbed being directly related to the CO<sub>2</sub> concentration. When an IR beam is passed through a gas sample containing CO<sub>2</sub>, the electronic signal from the photodetector (which measures the remaining light energy) can be obtained. This signal is then compared to the energy of the IR source and calibrated to accurately reflect CO<sub>2</sub> concentration in the sample. To calibrate, the photodetector's response to a known concentration of CO<sub>2</sub> is stored at the factory in the monitor's memory. A reference channel accounts for optical changes in the sensor, allowing the system to remain in calibration without user intervention.

### SpO<sub>2</sub>

The *TIDAL WAVE<sup>®</sup> Sp* determines oxygen saturation using sensors that contain red and infrared (660 and 940 nanometer) light sources, called light emitting diodes (LEDs). The light energy from each LED is beamed through a tissue sample—a pulsating vascular bed such as the patient's finger or toe. The remaining light energy not absorbed by the tissue sample reaches a photodiode light receptor in the sensor. Oxygen saturated blood absorbs

different amounts of light at each wavelength as compared to desaturated blood. Therefore, the amount of light absorbed by the blood in each pulse can be used to calculate oxygen saturation.

The *TIDAL WAVE*<sup>®</sup> *Sp* is calibrated to display “functional” saturation. This differs from the “fractional” saturation value displayed by most co-oximeters. Functional saturation is defined as:

$$\text{Functional Saturation} = \frac{\text{HbO}_2}{100 - (\text{COHb} + \text{METHb})}$$

HbO<sub>2</sub> = Fractional Oxyhemoglobin

COHb = Carboxyhemoglobin

METHb = Methemoglobin

This can be considered to represent the amount of oxyhemoglobin as a percentage of the hemoglobin that can be oxygenated. Dysfunctional hemoglobins (COHb and METHb) are not included in the measurement of functional saturation.

Pulse Rate is calculated by measuring the time interval between peaks of the infrared light waveform. The inverse of this measurement is displayed as pulse rate.

The oxygen saturation and pulse rate values are updated once each second. Presence of a pulse is indicated visibly by a plethysmogram graphic display and audibly by a “beep,” when configured.

The *TIDAL WAVE*<sup>®</sup> *Sp* must be used in conjunction with SuperBright™ Sensors. See “Accessories” on page 59 for a list of available sensors and accessories.

## Section 2

## Safety

For maximum patient and operator safety, you must follow the following warnings and cautions.



### WARNINGS

Indicates a potentially harmful condition that can lead to personal injury.

- **Explosion Hazard:** *DO NOT* use *TIDAL WAVE*<sup>(®)</sup> *Sp* in the presence of flammable anesthetics. Use of this instrument in such an environment may present an explosion hazard.
- **Electrical Shock Hazard:** Always turn *TIDAL WAVE*<sup>(®)</sup> *Sp* off and remove any external devices before cleaning it. Refer servicing to qualified service personnel.
- **Failure of Operation:** If the monitor fails to respond as described, do not use it until the situation has been corrected by qualified personnel.
- Do not operate *TIDAL WAVE*<sup>(®)</sup> *Sp* if it appears to have been dropped or damaged.
- Do not operate *TIDAL WAVE*<sup>(®)</sup> *Sp* or its accessories when it is wet due to spills or condensation.
- Never sterilize or immerse the monitor, sensor or accessories in liquids.
- The monitor does not alert for NO RESPIRATION if the airway adapter is removed from the CAPNOSTAT<sup>(®)</sup> CO<sub>2</sub> sensor.
- Verify the "No Resp Timer" setting prior to use.
- Do not position any sensor cable in a way that may cause entanglement or strangulation.
- The *TIDAL WAVE*<sup>(®)</sup> *Sp* is not intended to be used as a primary diagnostic apnea monitor and/or recording device.
- Patient Safety: Care should be exercised to assure continued peripheral perfusion distal to the SpO<sub>2</sub> sensor site after application.
- Inspect the SpO<sub>2</sub> sensor site often for adequate circulation - at least once every four hours. When applying sensors take note of patient's physiological condition. For example, burn patients may exhibit more sensitivity to heat and pressure and therefore additional consideration such as more frequent site checks may be appropriate.
- Data Validity: As with all pulse oximeters, inaccurate SpO<sub>2</sub> and Pulse Rate values may be caused by:
  - Incorrect application or use of sensor;
  - Significant levels of dysfunctional hemoglobin; carboxyhemoglobin or methemoglobin;
  - Significant levels of indocyanine green, methylene blue, or other intravascular dyes;
  - Exposure to excessive illumination such as surgical lamps-especially those with a xenon light source, or direct sunlight;
  - Excessive patient movement;
  - Venous pulsations;
  - Electrosurgical interference.
- The external battery charger should NOT be used to recharge the battery near or in close proximity to patients and/or other medical equipment in operation. It is intended for use in service areas only (i.e. nurses station, biomed lab, etc.).

## Section 2

- Connection of an external device (e.g. printer or computer) to the RS232 serial port on the BaseStation may compromise patient safety.
- Use of the *TIDAL WAVE<sup>®</sup> Sp* monitor is restricted to one patient at a time. Do not connect the sensors to multiple patients simultaneously.
- The *TIDAL WAVE<sup>®</sup> Sp* monitor provides no protection against the effects of a defibrillator. The patient sensors must not be located between defibrillator pads when a defibrillator is used on a patient.
- To reduce the hazard of burns in the high-frequency surgical neutral electrode connection, the patient sensors should not be located between the surgical site and the electro-surgical unit return electrode.
- The use of accessories, sensors and cables other than those specified by Respirationics may increase emissions or decrease immunity of the equipment.
- The use of portable and mobile radio frequency (RF) communications equipment can affect this and other pieces of medical equipment.



### CAUTIONS

Indicates a condition that may lead to equipment damage or malfunction.

- Caution: Federal (U.S.A.) law restricts this device to sale, distribution, or use by or on the order of a licensed medical practitioner.
- Use only an external power supply approved by Respirationics for use with this device. Use of any other power supply may damage the *TIDAL WAVE<sup>®</sup> Sp* and void the warranty.
- Do not operate *TIDAL WAVE<sup>®</sup> Sp* or its accessories when it is wet due to spills or condensation.
- Do not operate *TIDAL WAVE<sup>®</sup> Sp* if it appears to have been dropped or damaged.
- Keep *TIDAL WAVE<sup>®</sup> Sp* and its accessories clean.
- Inspect the integrity of the *TIDAL WAVE<sup>®</sup> Sp* and its accessories prior to use.
- Never sterilize or immerse the monitor, sensor or accessories in liquids.
- Do not sterilize or immerse sensors except as directed in this manual.
- Do not apply excessive tension to any sensor cable or pneumatic tubing.
- Do not store the monitor or sensors at temperatures less than 14°F (-10°C) or above 131°F (55°C).
- Do not operate the monitor or sensors at temperatures below 50°F (10°C) or above 104°F (40°C).
- If a Single Patient Use Sampling Adapter becomes occluded, replace and discard the adapter.
- It is recommended that the CAPNOSTAT<sup>®</sup> CO<sub>2</sub> sensor be removed from the circuit whenever an aerosolized medication is delivered. This is due to the increased viscosity of the medications which may contaminate the sensor windows, causing the sensor to fail prematurely.
- Where electromagnetic devices (i.e. electrocautery) are used, patient monitoring may be interrupted due to electromagnetic interference. Electromagnetic fields up to 3V/m will not adversely affect system performance.
- Refer servicing to qualified personnel.
- Use only approved sensors and accessories with the *TIDAL WAVE<sup>®</sup> Sp* monitor.
- Observe precautions for electrostatic discharge (ESD) and electromagnetic interference (EMI) to and from other equipment.
- Where electromagnetic devices (i.e., electrocautery) are used, patient monitoring may be interrupted due to electromagnetic interference. Electromagnetic fields up to 3 V/m will not adversely affect system performance.
- Sudden erratic changes in the CO<sub>2</sub> and pressure waveforms that do not correlate to the physiological condition of the patient may be signs that the monitor is experiencing electromagnetic interference.



- The *TIDAL WAVE<sup>®</sup> Sp* monitor should not be used adjacent to or stacked with other equipment; if adjacent or stacked use is necessary, the equipment should be observed to verify normal operation in the configuration in which it will be used.
  - The *TIDAL WAVE<sup>®</sup> Sp* monitor complies with IEC 60601-1-2:2001, providing reasonable protection against electromagnetic interference in a typical medical installation. The equipment generates, uses and can radiate electromagnetic interference (EMI), and if not installed and used in accordance with the instructions, may cause interference with other devices in the vicinity.
- If interference does occur, correct it using one or more of the following measures:
- Move the receiving device or increase separation between the equipment.
  - Consult Respirationics or members of the hospital's engineering department for more information.
  - If required by national or local codes, connect the *TIDAL WAVE<sup>®</sup> Sp* monitor to the hospital equalization connector with an equipotential cable.
  - The *TIDAL WAVE<sup>®</sup> Sp* monitor is not intended for use in a hyperbaric chamber or an MRI (Magnetic Resonance Imaging) environment.

### NOTES

Indicates points of particular interest or emphasis for more efficient or convenient operation.

- The *TIDAL WAVE<sup>®</sup> Sp* monitor is intended for operation with Respirationics Single Patient Use airway adapters.
- Operating the *TIDAL WAVE<sup>®</sup> Sp* below 50°F (10°C) will result in longer warm-up time and reduce battery life.
- Components of this product and its associated accessories which have patient contact are free of latex.
- Certain rebreathing circuits, or the presence of artifacts such as cardiogenic oscillations, may cause *TIDAL WAVE<sup>®</sup> Sp* to react to non-respiratory CO<sub>2</sub> fluctuations as if they were breaths. This condition affects the RE:SP numerical displays and may also affect the ETCO<sub>2</sub> display when using single breath averaging; the capnogram display continues to provide an accurate picture of the CO<sub>2</sub> waveform.
- After the life cycle of our equipment and all accessories has been met, disposal of the equipment should be accomplished following the national requirements. Contact the local Respirationics representative for questions concerning disposal.
- Accessories equipment connected to the analog and digital interfaces must be certified to the respective IEC standards: IEC 60950 for data processing equipment and IEC 60601-1 for medical equipment. Furthermore, all configurations shall comply with the system standard IEC 60601-1-1.

## Section 2

[This page intentionally blank.]

## Section 3



## Preparation for Use

---

The *TIDAL WAVE<sup>®</sup> Sp* can be powered four ways: from seven “AA” disposable lithium batteries, a rechargeable DR30 NiMH battery, the 9220-10 external power supply or the 6998-00 BaseStation combined with the external power supply, all available from Respirationics.

### AC/Battery Operation

---

Press the  POWER key to place the unit into operate mode (ON) or to turn the unit OFF. The status of the unit is dependent upon both the  Power key and the power source.

The monitor can operate for up to 4.5 hours while powered from a fully charged internal battery (4 hours when using sampling pump, Model 715). The battery is charging when the monitor is powered through its DC input and the keypanel  icon is green. The battery will charge even if the monitor is off. Power to the DC input is supplied by the external power supply (Cat. No. 9220-10) with or without the optional BaseStation (Cat. No. 6998-00).

Rechargeable and disposable battery capacity is shown in the table titled, “Battery Life and Recharge Times” on page 16. Times may be reduced in colder temperatures or with the sampling adapter; operation with the backlight off may slightly increase these times.

### Battery Status and Alerts

---

When the monitor is operating on battery power, and the battery is sufficiently charged, the battery icon LED  on the keypanel will be green. The battery level is reflected on the battery icon by different colors (for example, battery fully charged: green, battery low: flashing yellow).

The  LED on the keypanel flashes red when the monitor is powered by its internal battery and approximately 5 minutes remain. The monitor will sound an audible alert, then when the battery is depleted, turn itself off. This alert can only be silenced by connecting the external supply or turning the monitor off. The NiMH battery pack should be replaced, or the *TIDAL WAVE<sup>®</sup> Sp* BaseStation (Cat. No. 6998-00) or external power supply (Cat. No. 9220-10) should be connected to recharge the battery (rechargeable batteries only) and power the monitor. See “Battery Life and Recharge Times” on page 16.

#### NOTE

When the battery is low (red blinking battery LED  on keypanel) the monitor has shut down CO<sub>2</sub> and SpO<sub>2</sub> functions. Connect to AC power as soon as possible.

**NOTE**

- The battery life indicator may not reflect the true battery status upon power-up for approximately 30 seconds.
- The battery life indicator is inactive when the monitor is powered by the BaseStation or the external power supply.

## ***Battery Use and Options***

---

### ***Removing and Installing the Battery***

Grasp the finger grips on each end of the battery cover. Squeeze together and pull so that the cover opens to reveal the internal battery (the cover is hinged on the bottom of the case). Remove the battery from the monitor.

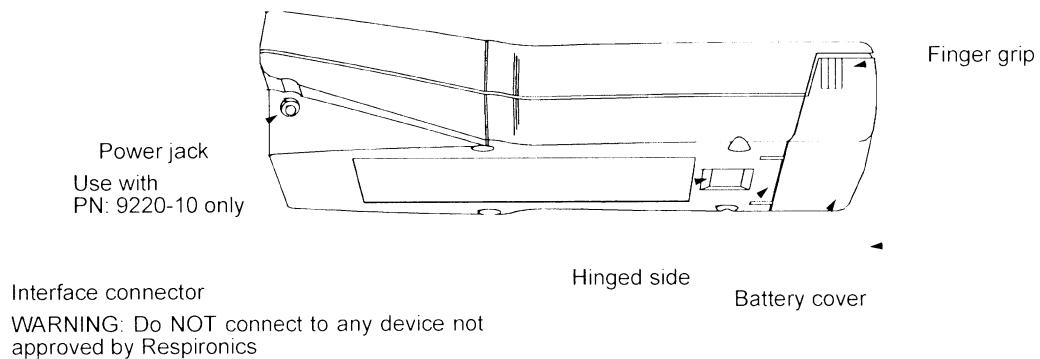

The battery is keyed so that it can be installed in only one way (see illustration inside battery compartment). The contacts should go in first and be located toward the top left of the monitor when inserting. Make certain the battery cover is properly closed before operating the monitor.

### Rechargeable Batteries

The DR30 NiMH rechargeable battery pack (Cat. No. 400043) can be used to power the *TIDAL WAVE<sup>®</sup> Sp* for approximately 4.5 hours of continuous operation (4 hours when using sampling pump, Model 715).

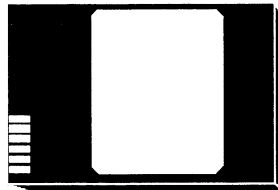

Optional DR30  
Rechargeable battery.  
(NiMH 7.2 vdc)

#### NOTE

- Refer to the instruction sheet packaged with the rechargeable battery for complete operating instructions.

#### To charge a rechargeable battery while in the monitor:

##### External Power Supply

Alternatively, plug the external power supply directly into the DC power jack on the side of the monitor, and connect a hospital-grade line cord to an AC source. The AC icon  will illuminate green and the battery will charge in approximately 5.5 hours. If the monitor has been stored with the battery installed for thirty (30) days or more, charge the battery for 24 hours prior to use.

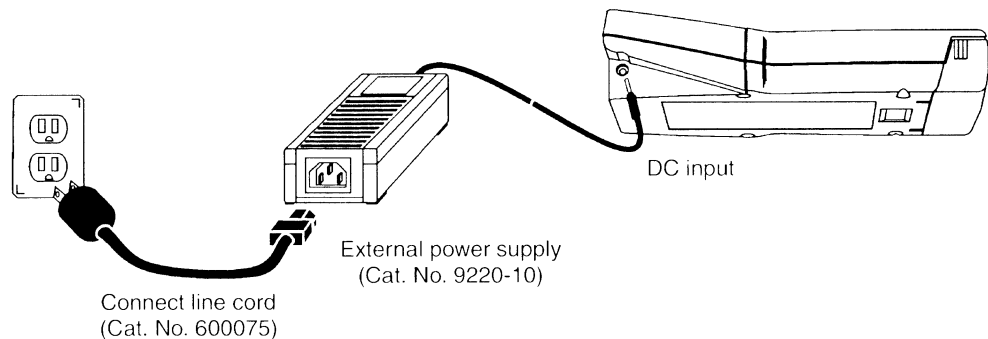

#### CAUTION

- Use only Respironics supplied devices when connecting to the power input jacks on the *TIDAL WAVE<sup>®</sup> Sp* or on the BaseStation.
- Do not attempt to use the adapter for the external battery charger for this function.

#### NOTE

- When powered by the external power supply, the *TIDAL WAVE<sup>®</sup> Sp* will not overcharge a rechargeable battery.
- The external power supply has a universal power input. The IEC 320 input receptacle for line cord connection allows compatibility with every country's voltage and frequency requirements.



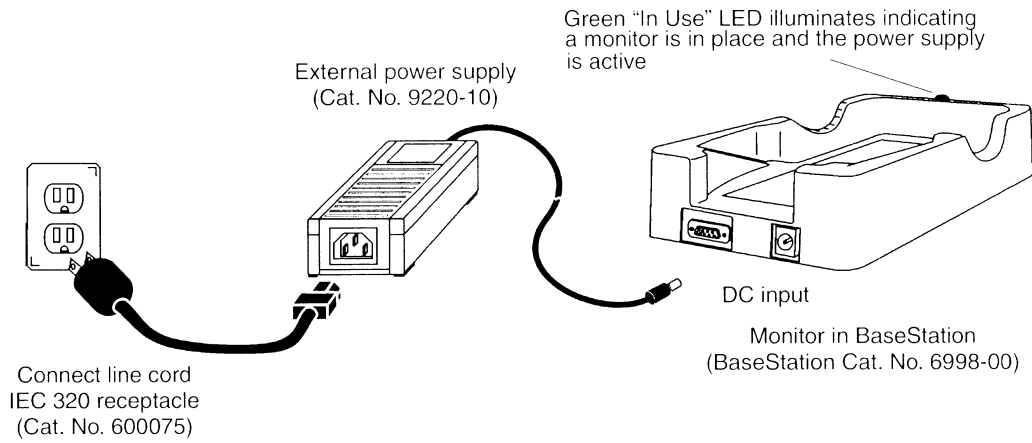

**Optional BaseStation**

Power for the BaseStation is supplied by an external power supply (PN 9220-10) or the internal battery. When the power supply is properly connected to the BaseStation and a monitor is placed within the station the green, "In Use" LED will illuminate. The  icon on the monitor will also illuminate indicating that external power is connected.

Connect the external power supply jack to the monitor and connect a hospital-grade line cord from the external power supply to an AC source.



The 9220-10 Power Supply is approved by the following regulatory agencies:

- |   |   |   |
|---|---|---|
|  : Canadian Standards Assoc. |  : VDE (Germany)   |  : DEMKO (Denmark) |
|  : SEMKO (Sweden)            |  : FINKO (Finland) |   |

**CAUTION**

- Although other connectors may physically fit, do not attempt to connect any device other than power supplies approved by Respirationics for use with this device. Doing so may damage the *TIDAL WAVE<sup>SM</sup> Sp* and will void the warranty.
- Never sterilize or immerse the monitor, sensor or accessories in liquids.

**Charging NiMH Rechargeable Battery with External Charger**

In a non-patient area, connect the adapter to an AC source, then plug the adapter jack into the charger. Remove the battery from the *TIDAL WAVE<sup>®</sup> Sp* and insert it into the external charger. The battery will be fully charged in approximately 4.5 hours. The external charger is for use with the DR30 NiMH rechargeable battery pack (Cat. No. 400043) only. Refer to the instructions supplied with the charger for additional information.

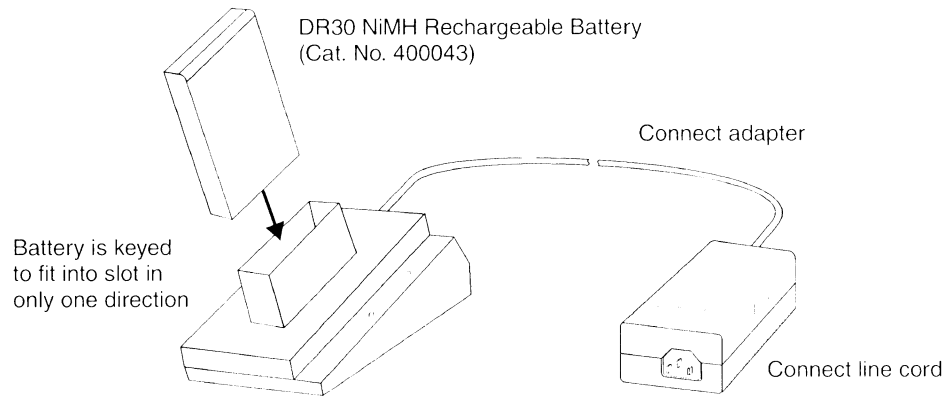
**WARNING**

- The external battery charger should NOT be used to recharge the battery near or in close proximity to patients and/or other medical equipment in operation. It is intended for use in service areas only (i.e. nurses station, biomed lab, etc.).

**NOTE**

- With a new battery, or a battery that has not been used for 30 days or more, charge the battery for 24 hours prior to use.
- When powered by the external power supply or the BaseStation, the *TIDAL WAVE<sup>®</sup> Sp* will not overcharge a rechargeable battery.
- The monitor may not operate on battery power if the battery is not sufficiently charged.
- Dispose of batteries in accordance with local laws.

**AA Lithium Batteries**

To power *TIDAL WAVE<sup>Sp</sup>* from AA lithium batteries, insert seven disposable batteries (Energizer L91 or equivalent) into the optional Battery Case (Cat. No. 6862-00) following the polarity markings on the Battery Case.

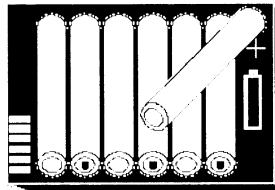

Standard  
AA lithium batteries  
(7 ea. - disposable)

**WARNING**

- Batteries can explode, leak or catch on fire if heated or exposed to fire or high temperatures.
- Do not mix battery types (e.g. disposable and rechargeable AA batteries).

**Battery Life and Recharge Times**

Configuring the monitor to turn off unused functions will result in longer battery life. The following table lists battery operation times with Sampling pump off (Model 710/715), Sampling pump on (Model 715) for each mode: CO<sub>2</sub>/SpO<sub>2</sub>, CO<sub>2</sub>, or SpO<sub>2</sub>. See “Monitoring Mode” on page 37.

Configuration	Power source - Approximate Monitoring Times	
	Rechargeable DR30 NiMH battery	AA lithium batteries
Model 710/715 - CO <sub>2</sub> /SpO <sub>2</sub>	4.5 hours	4.0 hours
Model 715 - CO <sub>2</sub> Sampling/SpO <sub>2</sub>	4.0 hours	3.5 hours
Model 710/715 - CO <sub>2</sub> only	4.5 hours	4.0 hours
Model 715 - CO <sub>2</sub> Sampling only	4.0 hours	3.5 hours
Model 710/715 - SpO <sub>2</sub> only	7.0 hours	6.5 hours
Recharge Time: External charger w/adapter	4.5 hours	n/a
Recharge Time: External power supply or External power supply/BaseStation	5.5 hours (in monitor)	n/a

**NOTE**

Excessive alerting reduces battery life when operating on battery power.



### **Automatic Power Off Feature**

The automatic power off feature is included to conserve battery power in the event of an unintentional power up of the monitor. This option will shut the monitor off if there is no CO<sub>2</sub> breath or pulse detection after 5 minutes from when the unit powers on, or after 20 minutes of no monitoring (no breath or pulse detected and no alert conditions). After the 5 or 20 minutes has elapsed, an AUTO POWER OFF IN X:XX message will appear on the screen and the timer (X:XX) will count down from one minute to zero. Pressing the adapter key, or detection of a CO<sub>2</sub> breath or pulse will cancel the shutdown, otherwise the unit will shut off.

### **Long Term Storage**

If the monitor has not been used or powered by the external power supply for an extended time<sup>⊘</sup> (3 months or more) allow the battery to charge before use or replace the battery with a fully charged battery and continue monitoring. The monitor may not power up on battery power if the battery is not sufficiently charged. Refer to "Battery Life and Recharge Times" on page 16.

#### **NOTE**

- New batteries, or batteries stored for extended periods of time may need to be fully charged and discharged up to five (5) times before performing at full capacity.
- With a new battery, or a battery that has not been used for 30 days, charge the battery for 24 hours prior to use.

### **Serial Communications/Power Interface Connector**

Located on the enclosure rear is a six pin modular contact which provides an RS232 interface as well as a power input for unit operation and battery charging when connected to Respiroics accessories. This connector meets the patient safety requirements of the following agencies: IEC 60601-1.

The BaseStation (Cat. No. 6998-00) is an optional accessory onto which Respiroics hand-held monitors can be placed, providing a platform for communication support between the monitor and a host computer or printer. The BaseStation is meant for table-top (horizontal), *not* pole-mounted (vertical) applications and can be used anywhere the *TIDAL WAVE<sup>®</sup> Sp* monitor is used; including but not limited to the sleep lab, ICU, anesthesia, post anesthesia, emergency department, respiratory care, home care, and pre-hospital emergency.

The BaseStation provides RS232 serial communications as supported by the monitor, with or without the external power supply connected. In addition, the BaseStation is capable of providing power to charge a rechargeable battery inside the monitor when used with the external power supply.

---

<sup>⊘</sup>The internal battery will slowly discharge over long periods of non-use.

## Configuration Menus

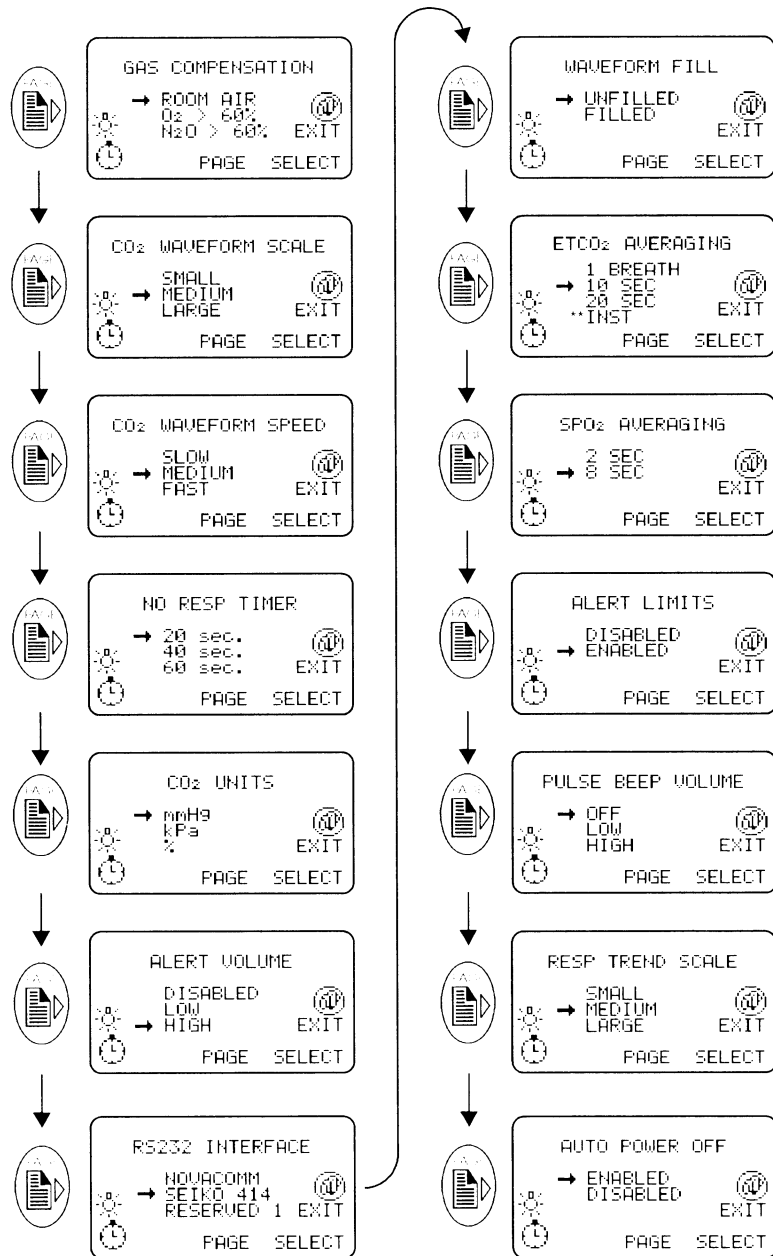

CONFIGURATION menus are provided on the *TIDAL WAVE<sup>®</sup> Sp* to allow customizing of various settings. To access the CONFIGURATION menus, press and hold the key, then simultaneously press the key until the first CONFIGURATION menu is displayed. Press the PAGE key to move through the menus. The SELECT key moves the arrow pointer; the parameter chosen will flash. Press the EXIT key at any time to return to monitoring mode (selections will be saved).



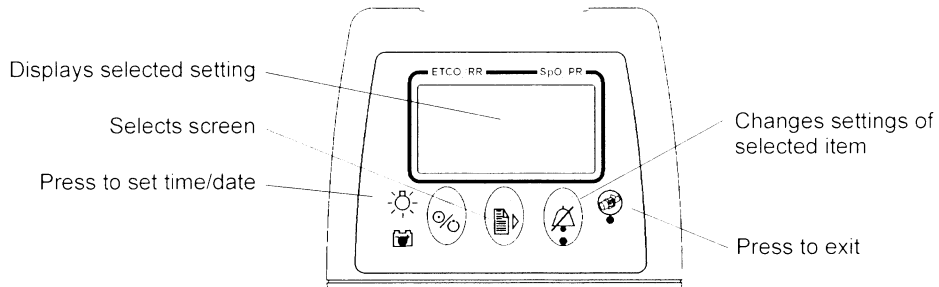

<sup>1</sup> Press SELECT to scroll down to INST in the EtCO<sub>2</sub> Averaging menu.



**NOTE**

If an attempt is made to change CO<sub>2</sub> units after data has been collected, a message warning that trend memory will be erased is displayed. To change units and erase trends, press the  OK key to continue, then the  EXIT key to confirm and exit.





### Configuration Settings

The CONFIGURATION menus can be programmed by the user to customize the *TIDAL WAVE<sup>®</sup> Sp*. Any changes made will be retained when the monitor is turned off. NOTE: To reset the monitor to its factory default settings: with the monitor off, press and **hold** the  key and the  key, then press the  key to turn the monitor on.

Options are listed below with descriptions following:

Parameter	Settings and Description	Factory Default
GAS COMPENSATION <sup>A</sup>	Room air, O <sub>2</sub> > 60%, N <sub>2</sub> O > 60% Use this setting to enter the gas composition in order to compensate the CO <sub>2</sub> measurement for gas density. Any setting other than the default will cause the monitor to display "O <sub>2</sub> " or "O <sub>2</sub> N <sub>2</sub> O" on the screen beside the respiration value.	Room Air
CO <sub>2</sub> WAVEFORM SCALE	Small, Medium, Large Select the desired size of the capnogram waveform.	Medium
CO <sub>2</sub> WAVEFORM SPEED	Slow, Fast, Medium Select the desired speed of the capnogram waveform.	Medium
NO RESP TIMER	20 sec., 40 sec., 60 sec. Alert setting activates if the end tidal CO <sub>2</sub> portion of the monitor cannot detect regular breaths for periods longer than 10 seconds.	20 sec.

A. If FiO<sub>2</sub> is less than 60% and N<sub>2</sub>O is selected as the balance gas, an incorrect INSP O<sub>2</sub> settings may cause the reported CO<sub>2</sub> value to be overestimated (too high) by up to 11.7% of its reading. If FiO<sub>2</sub> is greater than 60% and N<sub>2</sub> is selected as the balance gas, an incorrect INSP O<sub>2</sub> setting may cause the reported CO<sub>2</sub> value to be underestimated (too low) by up to 6.4% of its reading.

CO <sub>2</sub> UNITS	mmHg, kPa, % Select the desired units for both the capnogram and ETCO <sub>2</sub> values. Note that changing the CO <sub>2</sub> units in the Configuration menu will result in a loss of all stored data. The message "WARNING: CHANGING CO <sub>2</sub> UNITS ERASES STORED TRENDS" will display. Press CANCEL  , or press the  OK key to acknowledge the warning, and return to the CO <sub>2</sub> UNITS menu. Press the  Adapter key to EXIT	mmHg
ALERT VOLUME	Disabled, Low, High Select the desired volume of audible alerts. Note that care should be taken to set the volume level above ambient noise levels.	High
RS232 INTERFACE	NOVACOMM (used when connected to an external PC with optional software), RESERVED 1, and RESERVED 2 (Respirionics use).	NOVACOMM
WAVEFORM FILL	Unfilled, Filled Select the desired appearance of the capnogram waveform.	Unfilled
ETCO <sub>2</sub> AVERAGING	1 Breath, 10 sec, 20 sec, INST Select the interval from which the displayed value of end tidal CO <sub>2</sub> (ETCO <sub>2</sub> ) is calculated.	10 sec
SpO <sub>2</sub> AVERAGING	2 sec, 8 sec Select the interval from which the displayed value of oxygen saturation (SpO <sub>2</sub> ) is calculated.	8 sec
ALERT LIMITS	Disabled, Enabled Enable or disable the Alert Limits function. Select the desired high and low alert limits by exiting the CONFIGURATION menu and pressing the  Alert key.	Disabled
PULSE BEEP VOLUME	Off, Low, High Select the desired volume of pulse beep. Note that care should be taken to set the volume level above ambient noise levels.	OFF
RESP TREND SCALE	Small, Medium, Large Select the desired size of the respiration trend waveform.	Medium
AUTO POWER OFF	Enabled, Disabled Selects automatic shut off of unit if no signal is detected, to conserve battery power.	Enabled

The following parameters are accessed by pressing  from one of the previous Configuration menus. Press  to move through the menus.

SET TIME AND DATE	Press the 24 hour format. Day number, short month name, year (e.g. 14-DEC-1998) (From within the CONFIGURATION Menu, press  key to access this screen). Select to program or change the time and date. The format is "TIME: HH:MM DDmmmYYYY" where HH=hours from 00-23, MM=minutes from 00-59, DD=days of the month from 01-31, mmm=month, YYYY=year (using all four digits).	
LANGUAGE	All languages available in the current software release are listed in this menu.	
SOFTWARE REVISIONS MAIN PROGRAM	Date, time and version of 710/715 software currently loaded in to this unit.	
CAPNOSTAT SERIAL #	Serial number of CAPNOSTAT <sup>®</sup> CO <sub>2</sub> sensor attached to this monitor.	
VERIFY ACCURACY	Verifying monitor accuracy with calibration gas should be performed only by qualified service personnel.	

[This page intentionally blank.]



## Section 4

## Sensors and Patient Connections

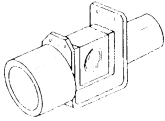
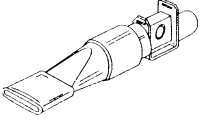
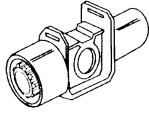
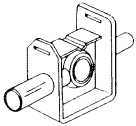
### Adapter Types Available

	<p><b>Pediatric/Adult Single Patient Use Airway Adapter</b> (Catalog No. 6063):</p> <ul style="list-style-type: none"><li>• For intubated patients with endotracheal tube diameters greater than 4 mm. Adds approximately 5 cc of deadspace;</li><li>• For connecting to anesthesia, non-rebreathing, or BIPAP/CPAP masks for non-intubated patients.</li></ul>
	<p><b>Pediatric/Adult Single Patient Use Airway Adapter with mouthpiece</b> (Catalog No. 6421):</p> <ul style="list-style-type: none"><li>• For point-of-care monitoring of pediatric or adult patients. Adds approximately 8 cc of deadspace.</li></ul>
	<p><b>Neonatal Single Patient Use Airway Adapter</b> (Catalog No. 6312):</p> <ul style="list-style-type: none"><li>• For intubated patients with endotracheal tube diameters no more than 4 mm. Adds approximately .5 cc of deadspace.</li></ul>
	<p><b>Sampling Adapter, Single Patient Use</b> (Catalog No. 8954):</p> <ul style="list-style-type: none"><li>• For monitoring non-intubated patients with nasal cannulas.</li><li>• For monitoring pediatric tracheostomy patients.</li></ul>

### Setting Adapter Type

The *TIDAL WAVE<sup>®</sup> Sp* uses three types of disposable, Single Patient Use adapters: Adult/Pediatric, Neonatal and Sampling. Press the  Adapter key to access the adapter menu, then the  SELECT key to move the arrow pointer to the correct type. The selected adapter type is displayed in the message area in the center of the display screen.

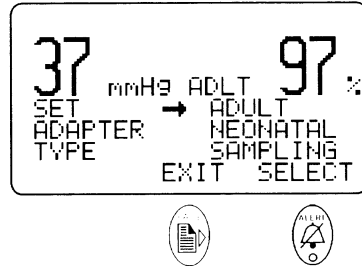





If the adapter type placed on the CAPNOSTAT<sup>®</sup> CO<sub>2</sub> sensor does not match the currently selected adapter type, a "CHECK ADAPTER" message will appear. If the adapter type is correct, see the "Adapter Zero Procedure" on page 24.

## Adapter Zero Procedure

An adapter zero allows the monitor to accommodate the optical characteristics of each different type of adapter. Before zeroing, verify the selected adapter type is correct, and the adapter setting is correct.

### NOTE



- This procedure is to be performed with a new unused single patient use adapter only! Perform this procedure only if the CHECK ADAPTER message persists, or if deemed necessary by qualified personnel.
- Do not perform this procedure while the CAPNO WARMING message is displayed.
- Do not perform this procedure while the adapter is connected to a breathing circuit, mouthpiece or mask on a patient.
- The pediatric/adult, neonatal and sampling adapters must be zeroed independently (ensure that the proper adapter type is selected).

1. Attach the selected adapter type to the CAPNOSTAT<sup>®</sup> CO<sub>2</sub> sensor. Select the adapter type (pediatric/adult, neonatal or sampling) to be zeroed by pressing the  Adapter key to access the adapter menu. Press the  SELECT key to move the arrow pointer to the correct type of adapter and confirm the selection with the  EXIT key.
2. Press and hold the  Adapter key for five seconds to enter the zero menu.

### WARNING



- Zeroing with the incorrect adapter type will cause incorrect readings.
- Zeroing the wrong adapter type on the wrong adapter setting will cause incorrect readings.
- Do not zero the CAPNOSTAT<sup>®</sup> CO<sub>2</sub> sensor without a single patient use adapter attached. Incorrect readings or no readings will result.

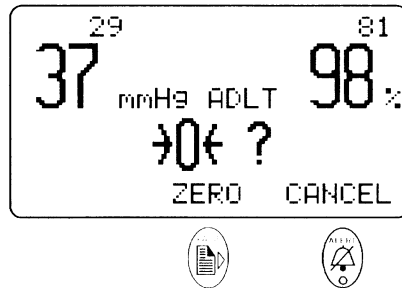

3. With all sources of CO<sub>2</sub> away from the adapter (including the patient's - and your own - exhaled breath), press the  ZERO key to begin the procedure or  CANCEL to exit.



#### NOTE

- If breaths are detected while attempting to zero the adapter, the  icon will display and the zero menu will be exited automatically (remove the CO<sub>2</sub> source, wait 15 seconds and repeat the procedure from step 1).
- If the sensor is not at the proper temperature, the  icon will display and the zero menu will be exited automatically (wait 15 seconds and repeat the procedure from step 1).
- The TIDAL WAVE<sup>®</sup> Sp will return to monitor mode automatically when the procedure is complete.
- When SAMPLING has been selected from the ADAPTER menu, the sampling pump will turn on when the CAPNOSTAT<sup>®</sup> CO<sub>2</sub> sensor is snapped onto the sampling adapter.
- When zeroing the sampling adapter, place the cannula away from all sources of CO<sub>2</sub> including patient and operator breath, and ventilator exhaust valves. Verify the integrity of all pneumatic connections.

## CAPNOSTAT® CO<sub>2</sub> Sensor and Airway Adapter Setup

### Patients requiring mechanical ventilation:

1. Select a new Single Patient Use airway adapter.  
(Pediatric/Adult - Cat. No. 6063 for ET tube size greater than 4.0 mm - see **Fig. 1**)  
(Neonatal Cat. No. 6312 for ET tube size 4.0 mm or less, see **Fig. 2**)  
Verify that the windows are clean and dry. Place the airway adapter in the patient's ventilator circuit. It should be positioned between the ET tube elbow and the circuit "wye" with its window in a vertical position.  
*NOTE:* In a pediatric or neonatal ventilator's circuit the elbow may not be present (**Fig. 2**).
2. Be sure the airway adapter is positioned vertically and located so that patient secretions and condensate water will flow **AWAY** from the adapter's windows, not through or into it.
3. Snap the CAPNOSTAT® CO<sub>2</sub> sensor onto the airway adapter.
4. Capnogram (CO<sub>2</sub> waveform) or EtCO<sub>2</sub> trend, EtCO<sub>2</sub> values, and respiratory rate should be displayed on the monitor.

(Fig. 1) Pediatric/Adult Single Patient Use airway adapter Cat. No. 6063

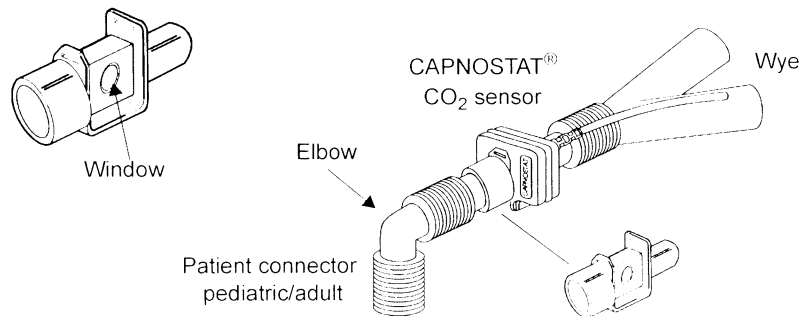

(Fig. 2) Neonatal Single Patient Use airway adapter Cat. No. 6312

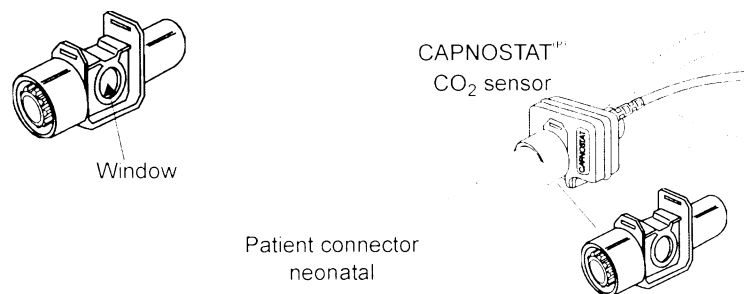

### Spontaneously Breathing, Non-Intubated Patients

Mouthpiece:

1. Select an airway adapter with mouthpiece (Cat. No. 6421. **Fig. 3**)
2. Snap the CAPNOSTAT® CO<sub>2</sub> sensor onto the airway adapter.
3. Instruct the patient to breath normally through his/her mouth while keeping a tight seal around the mouthpiece.

*NOTE:* It has been reported in the literature that the presence of a mouthpiece may alter a patient's breathing pattern. This usually has a minor impact on EtCO<sub>2</sub>.

(Fig. 3) Pediatric/adult with mouthpiece Cat. No. 6421

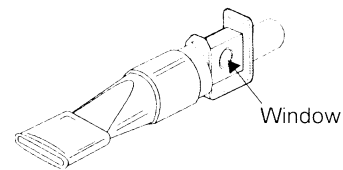

Mask:

1. Select a new Single Patient Use airway adapter (Pediatric/Adult Cat. No. 6063).
  2. Place the adapter onto a mask with a 22 mm connector (**Fig. 4**)
  3. Place the mask on the patient's face and instruct him/her to breath normally.
- NOTE:* If the patient requires low flow oxygen therapy it may be provided by placing the mask over the nasal cannula. This will have a minimal effect on EtCO<sub>2</sub> measurements.

(Fig. 4) Pediatric/Adult with Mask

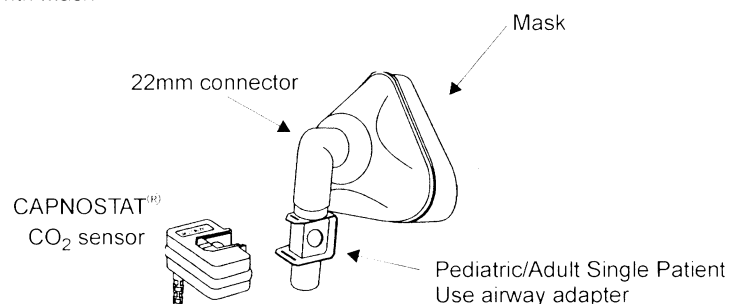

### Sidestream Sampling (Model 715)

The Single Patient Use Sampling Airway Adapter (Cat. No. 8954) should be used in conjunction with a nasal sampling cannula to monitor non-intubated patients.

1. Select a new Single Patient Use sampling adapter.
2. Align the arrow on the bottom of the sampling adapter with the arrow on the bottom of the CAPNOSTAT® CO<sub>2</sub> sensor and press the sensor and adapter together until they "click."



## Section 4

## CAPNOSTAT® CO<sub>2</sub> Sensor and Airway Adapter Setup

3. Connect the nasal cannula/sampling adapter assembly to the Sampling Inlet  port located on the end of the monitor.

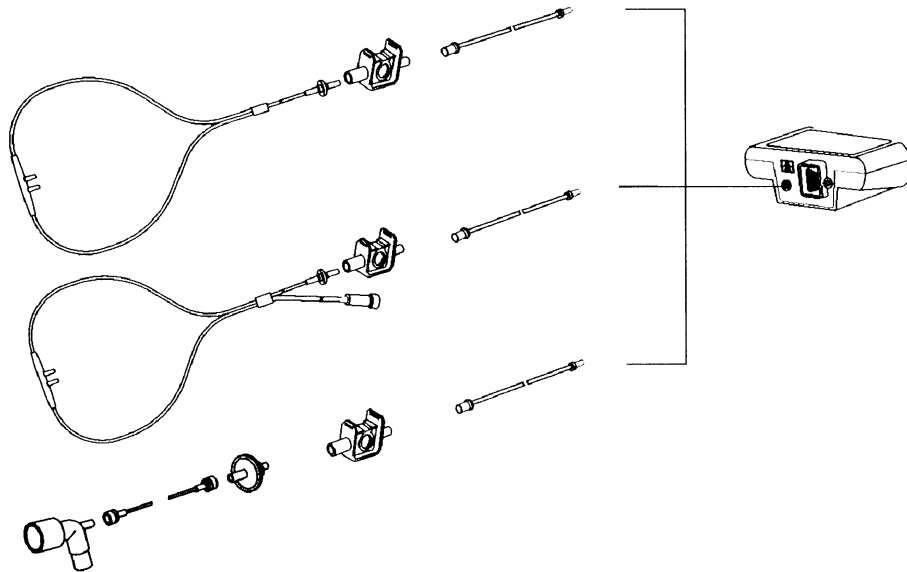
Cat. No.	Cannula Type
8955-00	Nasal CO <sub>2</sub> Sampling Cannula—Adult
8956-00	Nasal CO <sub>2</sub> Sampling Cannula—Pediatric
8957-00	Nasal CO <sub>2</sub> Sampling and O <sub>2</sub> Delivery Cannula—Adult
8958-00	Nasal CO <sub>2</sub> Sampling and O <sub>2</sub> Delivery Cannula—Pediatric
9675-00	Sidestream Sampling Kit
9906-00	Replacement Filters
3121-00	Sampling Tubing Kit



4. Ensure that the unit is in sampling mode:
  - a. Press the  Adapter key to set adapter type.
  - b. Use the  SELECT key until the arrow points to SAMPLING.
  - c. Press the  EXIT key to select SAMPLING.
5. When SAMPLING has been selected from the ADAPTER menu, the sampling pump will turn on when the CAPNOSTAT® CO<sub>2</sub> sensor is snapped onto the adapter. The sampling adapter requires a zero when the monitor displays "CHECK ADAPTER". To perform a zero, refer to "Adapter Zero Procedure" on page 24.
6. If using a Nasal CO<sub>2</sub> Sampling and O<sub>2</sub> Delivery Cannula, attach the O<sub>2</sub> tubing to the administration device and set the device to the prescribed O<sub>2</sub> setting.

7. Position the cannula on the patient.  
Insert the cannula tips into the nostrils, pass the cannula tubing over the ears, then slide the retaining sleeve up the tubing toward the neck to a comfortable fit under the chin.
8. Check that the connections have been made properly by examining the CO<sub>2</sub> waveform (capnogram) on the monitor display.

**NOTE**

- If possible, position the Sampling Adapter with its windows in a vertical, and NOT a horizontal position; this helps keep moisture from “pooling” on the windows.
- To prevent “rain-out” and moisture from draining into the Sampling Adapter, do NOT place the Sampling Adapter in a gravity dependent position.
- If a Single Patient Use Sampling Adapter becomes occluded, replace and discard the adapter.
- Device is not intended for returning analyzed gas to the breathing circuit.

**SpO<sub>2</sub> Sensors**

**CAUTION**

Connect only Respironics SpO<sub>2</sub> sensor extension cables and/or SuperBright™ SpO<sub>2</sub> sensors to the TIDAL WAVE® Sp. Do not use other SpO<sub>2</sub> sensors or accessories with TIDAL WAVE® Sp. Before connecting to the patient or to the monitor, ensure that sensor extension cables and/or sensors are physically intact, with no broken, frayed or damaged components.

1. Plug the connector into the end panel SpO<sub>2</sub> sensor input. The sensor connector is keyed to fit into the input in only one direction.

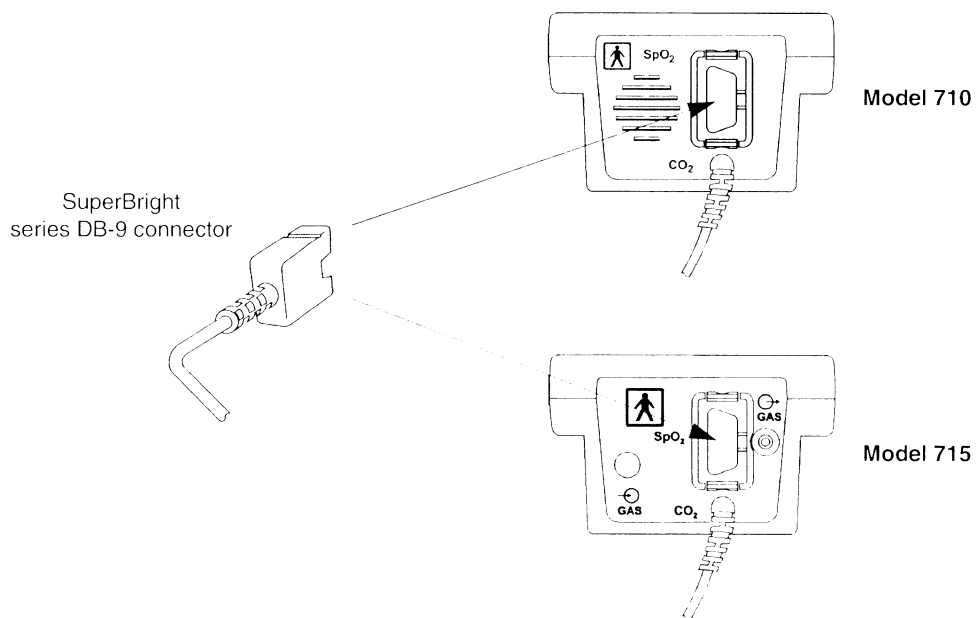

The connector clicks into place when properly seated. Sensors may be connected or removed whether or not the monitor is turned on.

### Finger Sensor

The reusable Finger Sensor is intended for adult or appropriate size pediatric fingers and is not designed for neonatal applications.

Figure 4-1



1. Gently squeeze the grips at the rear of the sensor (indicated by arrows below).

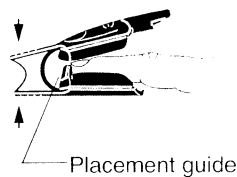

2. Position fingertip against placement guide with fingernail toward the red light.  
Do not position the finger so as to protrude past the placement guide.
3. Release the finger grips.

#### WARNING

Inspect the site often for adequate circulation—at least once every four hours. When applying sensors take note of patient's physiological condition. For example, burn patients may exhibit more sensitivity to heat and pressure and therefore additional consideration such as more frequent site checks may be appropriate.

4. To remove sensor, gently squeeze grips and slide the sensor from the finger.

#### CAUTION

Overstretching the pulse oximeter finger sensor can damage the sensor and potentially affect pulse oximeter readings. Do not stretch the finger sensor open beyond the limit for which it was designed. Overstretching can be prevented: avoid opening the sensor by any means other than squeezing the grips; *DO NOT* force the sensor onto large objects such as a bedrail.

**Finger Sensor Quick Check**

1. Is “SPO2 PRB OFF PAT” displayed when the sensor is connected to the monitor but not applied to the patient?
2. Apply the sensor to your index finger. Are reasonable SpO<sub>2</sub> and pulse rate values displayed?
3. A YES to BOTH #1 and #2 indicates that the sensor is OK. Apply the sensor to the patient as instructed above. The quick check is also a functional test of the extension cable.

**Y-Sensor™**

The reusable Y-Sensor is a flexible sensor designed for use on any patient. It is secured to the patient using a Y-Strip tape, foam wrap, or ear clip (see below).



**Y-Sensor™ Applicators**

The flexible and versatile Y-Sensor™ is applied to the patient using a variety of adhesive and non-adhesive applicators.

Treat applicators (except ear clip) in accordance with hospital protocol for single-patient use. Refer to instructions packaged with the various applicators.

	<ul style="list-style-type: none"> <li>• 8828-00: Neonatal/Pediatric Y-Strip™ Tape -Neonatal foot, hand, pediatric toe, finger</li> <li>• 8829-00: Adult Y-Strip™ Tape -Adult finger, toe</li> </ul>
	<ul style="list-style-type: none"> <li>• 8831-00: Pediatric Butterfly Wrap -Pediatric fingers</li> <li>• 8832-00: Adult Butterfly Wrap -Adult fingers</li> </ul>
	<ul style="list-style-type: none"> <li>• 8836-00: Non-Adhesive Foam Wrap, Large -Adult, pediatric or neonatal use</li> <li>• 8943-00: Non-Adhesive Foam Wrap, Small -Neonatal or appropriately sized pediatric patient use</li> </ul>
	<ul style="list-style-type: none"> <li>• 6929-00: Adhesive Foam Wraps, Large -Adult, pediatric or neonatal use</li> <li>• 6968-00: Adhesive Foam Wraps, Small -Neonatal or appropriately sized pediatric patient</li> </ul>
	<ul style="list-style-type: none"> <li>• 6131-00: Ear Clip -Adult use</li> </ul>

**To use the Y-Strip™ and Butterfly tapes:**

1. Insert sensor: With instructions facing up, press blue sensor buttons through holes in liner.

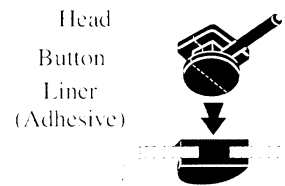

The spacing of the holes on the Neonatal/Pediatric Y-Strip™ allows customizing to different sized sites: first and second for pediatric toes or fingers, first and third for neonatal feet, hands and pediatric feet.



2. Remove liner: Peel tabs as indicated to remove liner and exposed adhesive.



3. Apply: Wrap the tape around the site with adhesive facing the skin.

If using the Butterfly Wrap, align the finger illustration on the tape over the patient's finger. Adhere the wings on the top side round the finger. Fold remaining wrap over finger tip. Adhere wrap to bottom of finger, fold wings up around finger to secure.

The sensor cable can be taped to the patient limb to further secure the sensor.

Adult/Pediatric Finger

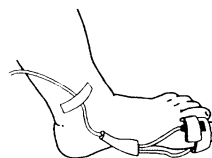
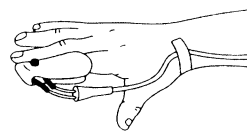

Pediatric Toe



**Using the Ear Clip:**

1. Slide each Y-Sensor™ head into an Ear Clip receptacle with the blue button facing outwards.
2. Open the clip by squeezing its ends and applying it to the ear.

It may be necessary to rub the ear with your fingers in order to increase circulation prior to applying the sensor.

Adhesive Dots (8700-00) are included with the ear clip to help hold the clip to the ear.

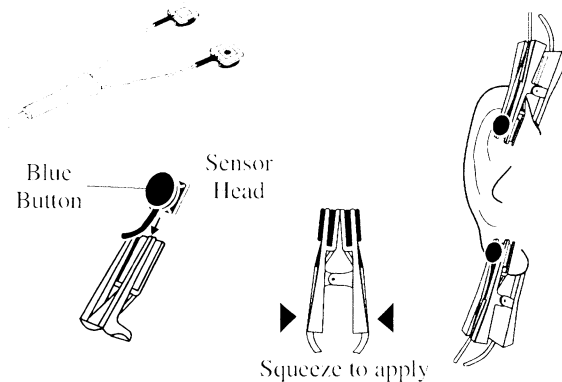
**To use the foam wraps:**

1. Insert sensor: Press each button through the blue side of the foam wrap.

**NOTE**

If using the first and third holes on the foam wrap it may be necessary to cut the center strip off the Y-sensor.

2. Remove liner: If using an adhesive foam wrap, pull tabs as indicated to remove liner.

**WARNING**

Do not wrap the tape around the limb so tightly that circulation is restricted. Inspect the site often for adequate circulation—at least once every four hours. When applying sensors take note of patient's physiological condition. For example, burn patients may exhibit more sensitivity to heat and pressure and therefore additional consideration such as more frequent site checks may be appropriate.

3. Apply: Wrap around the site with the blue side facing the skin. Secure in place with white plastic tab.

The tab on the small foam wrap is removable, allowing shortening for a better fit. Reapply the tab to secure the wrap in place.

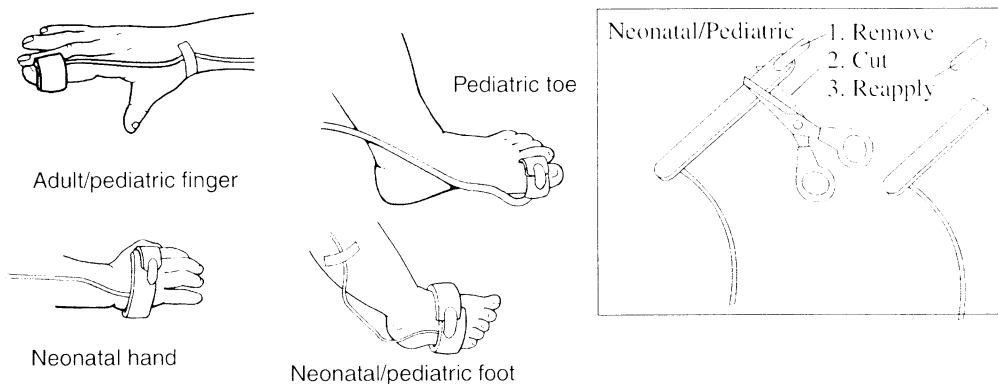

**WARNING**

Treat foam wrap in accordance with hospital protocol for single-patient use. Check site regularly to ensure adequate circulation and proper sensor positioning.

**Y-Sensor Quick Check**

1. With the Y-Sensor™ connected to the monitor but not applied to patient, position the sensor heads so that they face each other (the red light shines at the detector). Is "SPO2 PRB OFF PAT" displayed?
2. Tape the Y-Sensor™ to your index finger. Does the monitor show reasonable SpO<sub>2</sub> and pulse rate values?
3. A YES to BOTH #1 and #2 indicates that the sensor is working properly. Apply the sensor to the patient as instructed above. The quick check is also a functional test of the extension cable.

**Single Patient Use SpO<sub>2</sub> Sensors**

These Single Patient Use Sensors are for use on appropriately sized patients.

	<ul style="list-style-type: none"> <li>• 6455-25: Pediatric/Adult, Foam Wrap Style -Adult or appropriately sized pediatric patients</li> </ul>
	<ul style="list-style-type: none"> <li>• 6480-25: Neonatal/Pediatric, Foam Wrap Style -Neonatal or appropriately sized pediatric patients</li> </ul>

**WARNING**

Use the Single Patient Use sensor and DB-9 extension cable only with SuperBright compatible pulse oximeters. Use with any other device may result in equipment damage or patient injury.

**CAUTION**

These SpO<sub>2</sub> sensors are intended for single patient use. The sensors can be reapplied to various sites on the same patient but should not be used on multiple patients. Do not attempt to clean or disinfect the sensor, as system performance will be compromised.

**NOTE**

The Single Patient Use sensor should be discarded if sensor integrity becomes questionable.

1. Select the appropriate size sensor based on the patient type. Connect the DB-9 connector to the *TIDAL WAVE<sup>®</sup> Sp* rear panel connector.

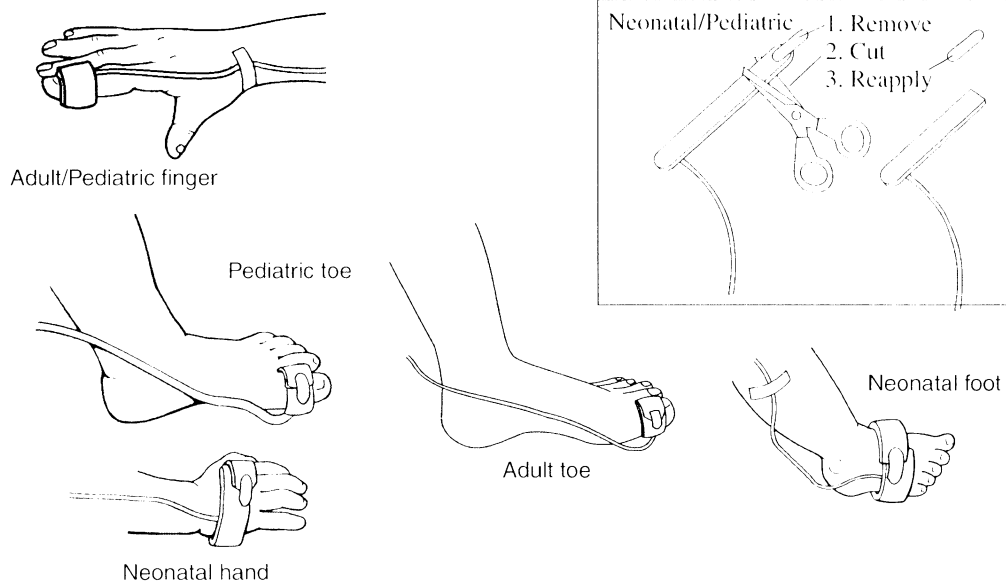

2. Wrap around the site with the blue side facing the skin. Secure in place with the white plastic tab. Ensure the sensor heads are opposite each other through the tissue. This prevents the sensor from being placed on a site that is too thick for proper operation. Position the sensor so that the tape does not extend over the space between the fingers or toes. This insures there will be no light transmission through this space.
3. The tab on the Neonatal/Pediatric sensor is removable, allowing shortening for a better fit. Reapply the tab to secure the sensor in place. Double-sided adhesive dots, included with the sensor, can be applied over the LED and detector components to help hold the sensor to the site.

An extension cable (Cat. No. 9174-00) is available for use with the disposable sensors.

**WARNING**

Do not wrap the sensor around the limb so tightly that circulation is restricted. Inspect the site often, at least every four hours, for adequate circulation. When applying sensors take note of patient's physiological condition. For example, burn patients may exhibit more sensitivity to heat and pressure and therefore additional consideration such as more frequent site checks may be appropriate.

***Single Patient Use SpO<sub>2</sub> Sensor Quick Check***



1. With the sensor connected to the monitor but not applied to patient, position the sensor heads so that they face each other (the red light shines at the detector). Is "SPO2 PRB OFF PAT" displayed on the screen?
2. Attach the Single Patient Use sensor to your index finger. Does the monitor show reasonable SpO<sub>2</sub> and pulse rate values?
3. A YES to BOTH #1 and #2 indicates that the sensor is working properly. Apply the sensor to the patient as instructed above. This quick check is also a functional test of the extension cable.

## Section 5



## Monitoring

### Display of Data

The *TIDAL WAVE<sup>SM</sup> Sp* measures and displays EtCO<sub>2</sub>, respiration rate, saturation and pulse rate. Until valid data is received for any parameter, that parameter will show a dash "--". When valid data is received, the value will display. If the parameter is lost, the value will return to dashes "--".

This will also occur when the monitor is first turned on and before any valid patient data is obtained. When monitoring, if valid data is received then lost for ETCO<sub>2</sub>, respiratory rate, SpO<sub>2</sub>, or pulse rate, an alert condition will occur. If the  Alert key is pressed, and valid data is still not available, the numeric value of the parameter in question will display "--". If the  key is not pressed within 30 seconds after the loss of data, the display will automatically turn to dashes "--".

### Monitoring Mode

Three monitoring modes are available for the *TIDAL WAVE<sup>SM</sup> Sp*: CO<sub>2</sub>/SpO<sub>2</sub>, CO<sub>2</sub> and SpO<sub>2</sub>. The factory default is CO<sub>2</sub>/SpO<sub>2</sub>. To choose a different mode, press and hold the  Power key to access the menu. The currently selected mode will flash. Press the  SELECT key to move the arrow pointer to the correct mode and the  EXIT key to exit the menu.

When the monitor is in CO<sub>2</sub> mode, SpO<sub>2</sub> screens are not be available; in SpO<sub>2</sub> mode, CO<sub>2</sub> screens are not available. All screens are available in CO<sub>2</sub>/SpO<sub>2</sub> mode.

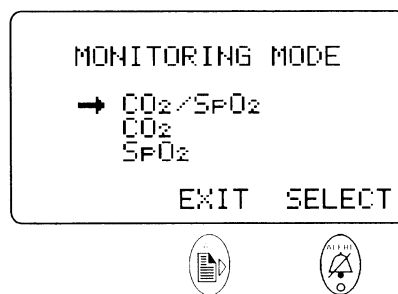

#### NOTE

Significant power savings can be realized by shutting down monitor functions that are not currently being used. Refer to "Battery Life and Recharge Times" on page 16.

Parameters are measured and displayed on the various screens in the following sections.

## Screen Displays

The last screen used will automatically appear on power-up, with the exception of the Trend screens.

### Data Screen

The Data screen displays End Tidal CO<sub>2</sub>, respiration rate, oxygen saturation, and pulse rate in larger, easy-to-read text, without waveforms. A pulse bar that is proportional to the signal strength, appears in the lower right corner, indicating the patient's pulse; a breath bar in the lower left corner indicates the patient's inhaled and exhaled breaths.

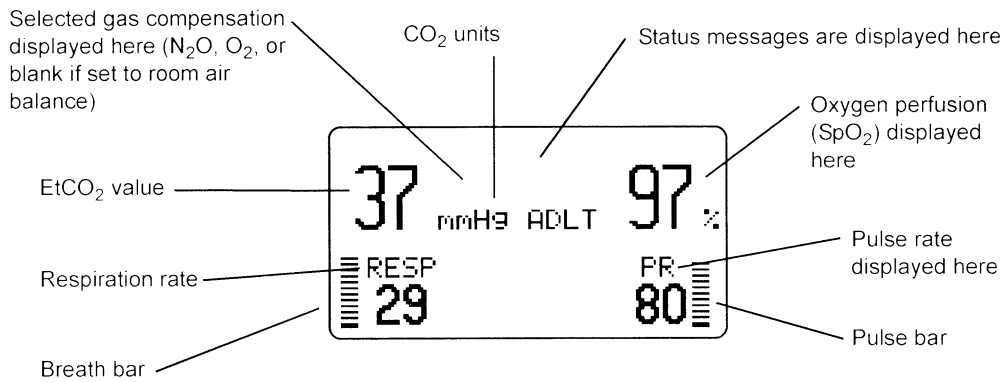

### CO<sub>2</sub> Waveform Screen (Capnogram)

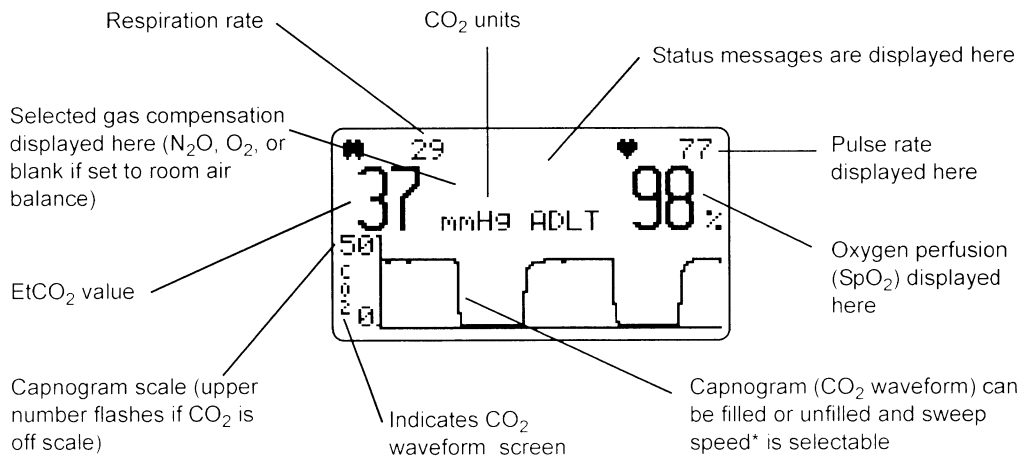

\*NOTE: The capnogram sweep speed is automatically adjusted when switching modes. It will increase one step when switched from adult to neonatal, and decrease one step when switched from neonatal to adult.

### SpO<sub>2</sub> Waveform Screen (Plethysmogram)

The pitch of the (user selectable) Pulse Rate “beep” tracks the SpO<sub>2</sub> value. Decreasing SpO<sub>2</sub> values are signaled by lower-pitched beeps; increasing values are signaled by higher-pitched beeps. The plethysmogram waveform is proportional to the signal strength.

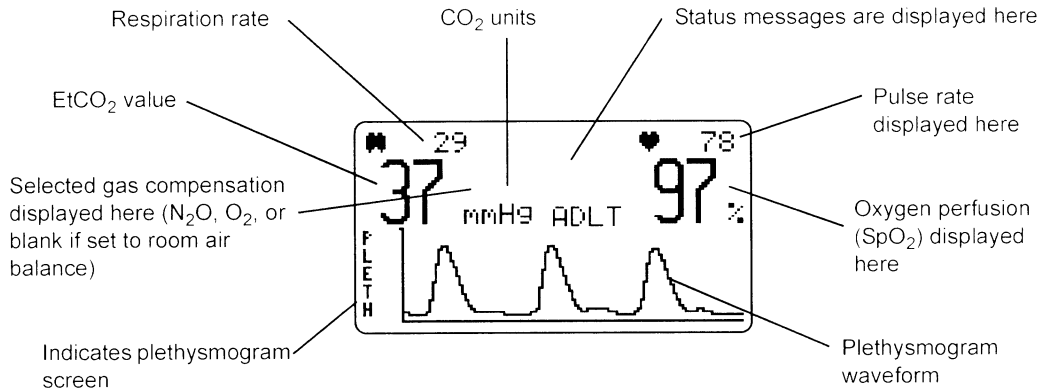

### Trend Screens

On-screen trends are displayed as a graph. Use the key to advance to the EtCO<sub>2</sub>, Respiration Rate or SpO<sub>2</sub> trend screen. Thirty (30) minutes of data are displayed, moving from right to left on the screen. Each data point represents 16.8 seconds. New data is added on the right side of the screen. Refer to the CONFIGURATION menus for scale adjustment.

**NOTE**

Changing the CO<sub>2</sub> UNITS in the Configuration menu will result in a loss of all stored data.

When changing CO<sub>2</sub> UNITS in the Configuration menu, the message “WARNING: CHANGING CO<sub>2</sub> UNITS ERASES STORED TRENDS” will display. Press the OK key to acknowledge the warning (this does not erase the data), and return to the CO<sub>2</sub> UNITS menu. Select the correct unit or press to EXIT.

EtCO<sub>2</sub> and Respiration Rate Trend Screen

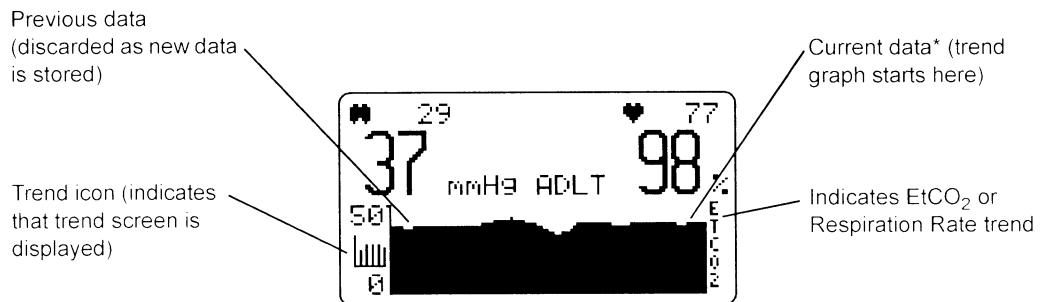

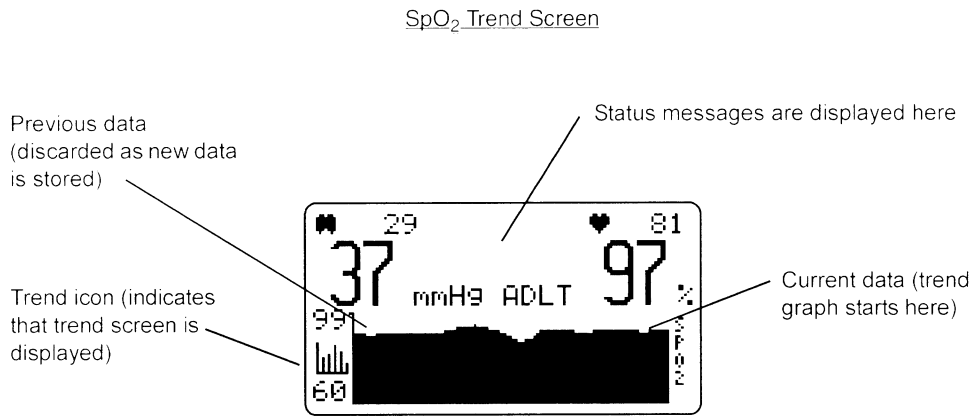

\* Thirty (30) minutes of data are displayed moving from right to left on the screen. Each data point represents 16.8 seconds.



**Trend Memory**

In addition to on-screen trends, the *TIDAL WAVE*<sup>®</sup> *Sp* has internal, battery-backed, trend memory that stores EtCO<sub>2</sub>, respiration rate, SpO<sub>2</sub> and pulse rate calculated parameters for 24 hours at an eight second resolution. The chart below describes the storage interval for each parameter. Stored parameter values can be downloaded (transferred) to a PC and viewed using the optional NovaCARD software. See “RS232 Options” on page 49 for more information.

To erase stored trends: hold both  and  keys during the power up cycle until “ERASING STORED TRENDS” appears on the display.

Trending Storage Interval	
ETCO <sub>2</sub>	Maximum value
Resp. Rate	Average
Inspired CO <sub>2</sub>	Maximum value
SpO <sub>2</sub>	Average
Pulse Rate	Average

**Messages**

---

**Status Messages**

Status messages indicate conditions that should be corrected or monitored; they may or may not be tied to an alert condition. These conditions can be a result of a hardware or sensor fault condition. Status messages are displayed on the screen in the same manner as alert messages. Following is a list of status and alert messages that may appear on the monitor.





**System Messages**

Message	Description
PRESSURE FAULTY	The barometric pressure sensor is returning a value which is out of range (<400 mmHg or > 800 mmHg). The monitor will default to 760 mmHg for calculation purposes. Refer servicing to qualified personnel.
EtCO <sub>2</sub> AUTO LIMITS SET SpO <sub>2</sub> AUTO LIMITS SET	This message is displayed when the monitor has successfully determined and set the auto alert limits for SpO <sub>2</sub> and EtCO <sub>2</sub> .
RESETTING TO FACTORY DEFAULTS	All setup and alert settings have just been reset to factory default values.
ERASING STORED TRENDS	The trends stored in the monitor's memory have been erased.
CHECK CLOCK TIME AND DATE	Time and date may not be properly set. The time and date can be adjusted in the CONFIGURATION menu by pressing the  Backlight key. See "Configuration Settings" on page 19.
AUTO POWER OFF IN X:XX	The monitor will shut off if there is no CO <sub>2</sub> breath detection or key depressions for ten minutes from when the unit powers on. The timer (X:XX) will then count down from two minutes to zero. Pressing the adapter key, or detection of a CO <sub>2</sub> breath will cancel the shutdown.
UNKNOWN ERROR	Remove the monitor from use and contact Respironics service personnel.

**Capnography Messages**

Message	Description
CAPNO WARMING	Sensor is under temperature. Wait for the CAPNOSTAT <sup>®</sup> CO <sub>2</sub> sensor to reach operating temperature.
CHECK ADAPTER	Excessive moisture or secretions detected in the adapter: Change adapter. Adapter type has been changed (e.g. adult to neonatal): Zero the adapter. No adapter detected: Place an adapter on the CAPNOSTAT <sup>®</sup> CO <sub>2</sub> sensor.
RESP=0 m : ss	A breath has not been detected for the indicated time (XX seconds). This message appears when the time since the end of expiration of the last detected breath exceeds the NO RESP TIMER setting in the configuration menu. See "Configuration Settings" on page 19.
INSP XX	An inspired CO <sub>2</sub> level of 3 mmHg (or 0.4% or kPa) was detected for 20 consecutive seconds.
ZRO: HOLD ADPT KEY	The current through the CAPNOSTAT <sup>®</sup> CO <sub>2</sub> sensor source emitter has changed or the system is detecting EtCO <sub>2</sub> values less than -3.0 mmHg.

Message	Description
CAPNO FAULTY	The following errors may be present: 1. The current through the source is too high or low. 2. The checksum for the CAPNOSTAT <sup>®</sup> calibration data is wrong. 3. The revision of the calibration data in the CAPNOSTAT <sup>®</sup> is not compatible with the software in the <i>TIDAL WAVE<sup>®</sup> Sp</i> Monitor. Refer servicing to qualified personnel.
CAPNO HI TEMP	The temperature of the case or detector heater is over 50°C. Refer servicing to qualified personnel.
CAN NOT ZERO CO2	An error was detected which did not allow the system to zero the current adapter being used. Refer servicing to qualified personnel.
CO <sub>2</sub> OUT OF RANGE	The detected waveform value is beyond the measurement range of the monitor (0-100 mmHg, 0-13.2% or kPa).
	A changing level of CO <sub>2</sub> was detected during an adapter zero procedure. Wait 30 seconds and retry.
	The CAPNOSTAT <sup>®</sup> CO <sub>2</sub> sensor has not reached operating temperature while attempting to zero. Wait for the sensor to reach operating temperature.
ADAPTER ZERO IN PROGRESS. TIME REMAINING 0 : XX	An airway adapter zero is in progress. XX indicates the number of seconds remaining.
WARNING: CHANGING CO2 UNITS ERASES STORED TRENDS	Changing CO <sub>2</sub> units (mmHg, %, kPa) in the Configuration menu will cause this message to appear.

### Oxygen Saturation Messages

Message	Description
SPO2 LOW STRENGTH	The pulse strength as detected by the sensor is too small for proper monitor operation. This message will disappear when the problem is corrected.
INSUFF LIGHT	Sensor is placed on a site too thick (opaque) for adequate light transmission. Move sensor to a different site.
PULSE RANG ERR	Pulse must be within 30-250 beats per minute, inclusive.
SHIELD SPO2 PRB	Ambient light source (sunlight, warming lights, etc.) are interfering with sensor operation. Shield sensor from these light sources.
SPO2 PRB FAULTY	Remove sensor from use and contact qualified service personnel.
SPO2 BAD SIGNAL	Monitor not receiving valid signals from the sensor. May be caused by excessive motion, cardiac arrhythmia or other situations leading to poor signal.
CONNECT SPO2 PRB	Sensor not connected to unit.

Message	Description
SPO2 PRB OFF PAT	Sensor not on patient.
MONITOR FAULTY	Remove the monitor from use and contact qualified service personnel.

## Alerts

Alerts are generated for ETCO<sub>2</sub>, respiration rate, SpO<sub>2</sub>, and pulse rate. These alerts occur when the high or low limits for a particular parameter are exceeded. There is also an alert when there is a loss of pulse rate, or when there is a loss of respiration for a consecutive twenty seconds (other limit times may be selected for the NO RESP TIMER, see "Configuration Menus" on page 18). Alert messages are displayed in the message center or in the particular area of the display when they occur. For example, a RESP=0 message will be displayed in the respiration section of the screen.

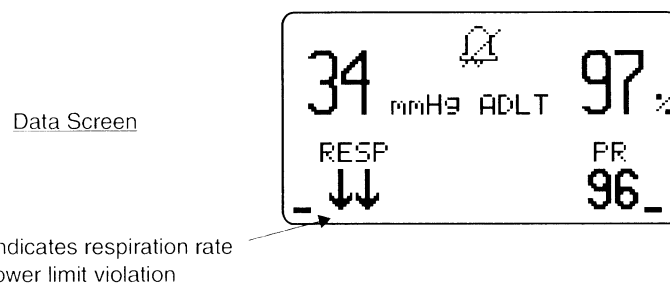

When any of the parameters are violated with alert limits ENABLED, two up ↑↑ or two down ↓↓ arrows will replace the parameter, indicating whether the violation was above or below the alert limit.





## Setting Alert Limits

The alert limits for the monitor can be manually or automatically adjusted. To access AUTO ALERTS or SET ALERTS, the alert limits must be ENABLED from the Configuration menu. See "Configuration Menus" on page 18.

### NOTE



To configure the monitor with the default limit values, power up while pressing and holding the  Backlight and  Alert keys. This will cause all parameters to return to their default values.

**Manually Setting Alert Limits**

Press the  Alert key to access the ALERT menu. Press the  SET ALERTS softkey to display the SET ALERT LIMITS menu. When selected, this screen will appear for 3 seconds, then automatically return to the previous display.

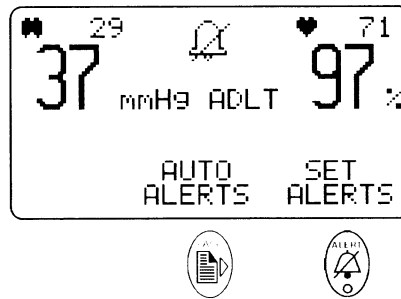
Alert Screen



Using the menu control keys, adjust the settings as desired: press the  SELECT key to move to the desired parameter for adjusting; the selected parameter will flash. Use the  Backlight key to decrease ↓ a parameter value and the  Adapter key to increase ↑ the selected value.

Maximum and minimum high and low limits are preset for each parameter and cannot be exceeded. Also, the range between high and low alert limits is restricted to a minimum of five units. For example, default ETCO<sub>2</sub> settings are, high: 55 mmHg, low: 25 mmHg. If the user decreases the high setting to 30 mmHg (within 5 units of the low setting), and continues to lower the setting, *both* high and low ETCO<sub>2</sub> settings will decrease, maintaining the five unit range.

Selected parameter will flash

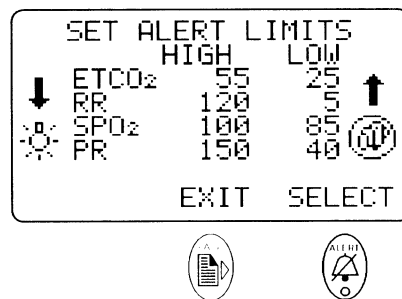



Default values are shown

**NOTE**

When the monitor is turned off, manual alert limit settings will be retained, even if AC power and the battery are disconnected.

Alert Limits Ranges	
ETCO <sub>2</sub>	150 max 10 min
Resp. Rate	150 max 5 min
SpO <sub>2</sub>	100 max 50 min
Pulse Rate	249 max 30 min

### Auto Alert Limits

To set alert limits automatically, press the  Alert key, and "AUTO ALERTS" will appear over the  Page key. Press the  Page key, and "ENABLE AUTO ALERTS?" will appear. Press "YES." The monitor will automatically set alert limits based on recent patient data.

Alert Screen

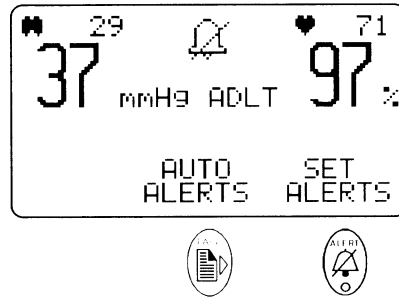

The screen will display "ETCO2 AUTO LIMITS SET" and "SPO2 AUTO LIMITS SET" messages. Press  CONTINUE to return to the previous screen. If auto alert limits cannot be determined for one or both limits, the message "ETCO2 AUTO LIMITS NOT SET" and/or "SPO2 AUTO LIMITS NOT SET" will appear.

If one or both of the screen messages say "LIMITS NOT SET," exit this screen, resume monitoring and retry in 30 seconds when the monitor has collected sufficient data.

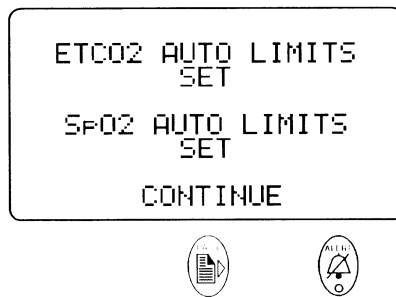

#### NOTE

Auto Alert Limits are not stored by the monitor. If Auto Alert Limits are selected and the unit is powered down, default limits will appear on power up, regardless of stored values.



### Alert Audio

A NO RESPIRATION alert will sound after 20, 40 or 60 seconds (depending upon the configuration setting) if no breaths are detected. When this occurs a RESP=0 timer appears, indicating the number of seconds since the last detected breath. Three breaths must first be detected to initialize this alarm.

An audible alert is generated any time an alert condition is detected, provided that neither the 2 minute suspend, nor the audible alert muting are enabled. If the ALERT VOLUME is set to DISABLED, an audible alert is not generated, and the alert silence LED will flash red.

Press the  Alert key to suspend an audible alert for 2 minutes. Press again to cancel.

Press and hold the  Alert key to disable audible alerts. Press and hold again to cancel. The monitor will always power up with the audible alerts settings retained in memory.

The audible alert volume can be adjusted or disabled from the CONFIGURATION menu. Press the  Backlight and  Adapter keys simultaneously, then the  Page key until the ALERT VOLUME menu appears.

**NOTE**

Make sure that the audible alert volume is not set too low to be heard over ambient noise levels.

## Capnogram Sample Waveforms and Interpretations

Normal: The “normal” capnogram is a waveform that represents the varying CO<sub>2</sub> level throughout the breath cycle.

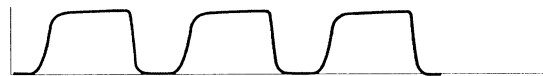

Rebreathing: Elevation of the baseline indicates rebreathing (may also show a corresponding increase in EtCO<sub>2</sub>).

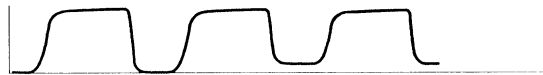

Obstruction: Obstructed expiratory gas flow is noted as a change in the slope of the ascending limb of the capnogram (the expiratory plateau may be absent).

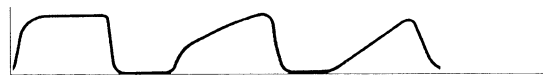

Endotracheal tube in the esophagus.



Inadequate seal around endotracheal tube: The downward slope of the plateau blends in with the descending limb.

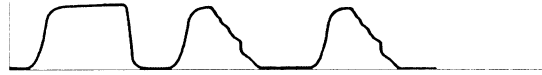

Accidental extubation:

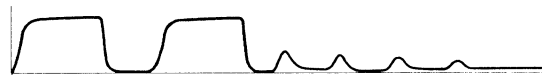

### **Reference Handbooks**

---

For a discussion on waveform interpretations, refer to the Novamatrix Reference Handbooks on capnography, respiratory mechanics, and pulse oximetry. Contact Respiration Customer Service or your local sales representative for more information.

[This page intentionally blank.]



## Section 6

## RS232 Options

### Power and RS232 Serial Port Communications

A serial communication mode is available for the Model 710/715. The NovaCOMM Interface is designed to output data in formats easily read by a computer or data logging device. The monitor must be placed in the BaseStation (PN: 6998-00) to use the serial communication mode.

Located on the BaseStation is a six pin modular contact which provides an RS232 interface as well as a power output for unit operation and battery charging when connected to Respirationics hand-held monitors. This connector meets the patient safety requirements of IEC 60601-1.

When the monitor is placed within the BaseStation, contact is made between the 6-pin connector in the BaseStation and the Features connector on the bottom of the monitor. This connection is transferred to the "RS232 Serial Port" connector on the BaseStation.

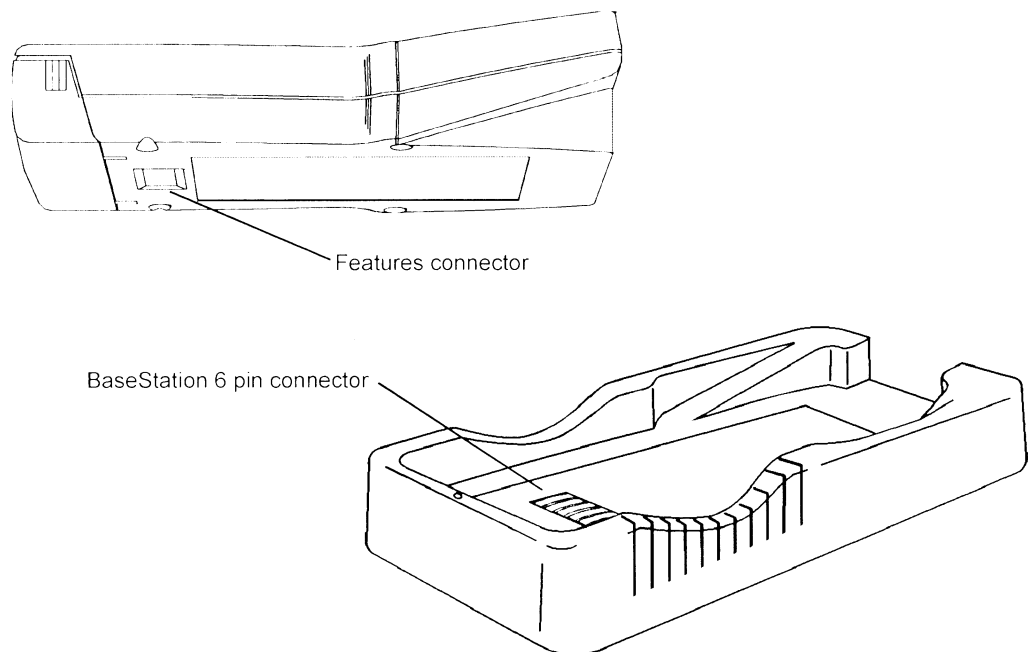

#### WARNING

Patient safety may be compromised if an external device (e.g. printer or computer) is connected to the RS232 serial port on the BaseStation.

The "RS232 Serial Port" 9 pin D connector allows connection to a host computer or printer.

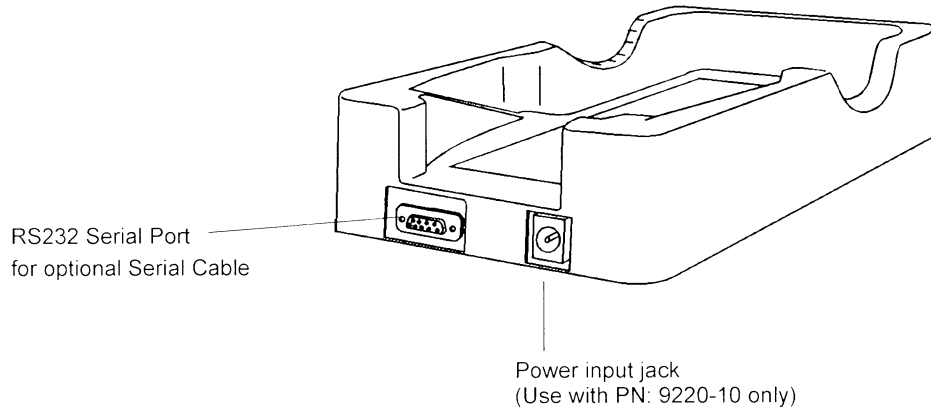

### **Downloading Data to a PC**

1. Connect the Serial Cable (PN: 600075, sold separately) to the RS232 Serial Port connector on the BaseStation.
2. Connect the external power supply to the power input jack on the BaseStation, then connect a line cord from the power supply to an AC source. It is recommended that the monitor be powered by the BaseStation using the external power supply when downloading data from the monitor or updating software. This will prevent power loss from a depleted battery.
3. Plug the other end of the serial cable into the host computer.  
NOTE: The COM port on the computer will be either a 9 pin or a 25 pin D connector. Use an adapter if the COM port on the host computer does not match the connector on the end of the Serial Cable.
4. Set the monitor inside the BaseStation, verify the "In Use"  LED illuminates. Refer to the 6993-23 BaseStation User's Manual for more information.

## Section 7

## Maintenance

---

### ***Cleaning and Sterilization***

---

Follow the cleaning and sterilization instructions listed below to clean and/or sterilize the monitor and its accessories.

#### ***Monitor, BaseStation and External Power Supply***

- Turn the monitor off, and unplug the BaseStation and the external power supply from the AC power source before cleaning.
- The monitor, BaseStation and external power supply can be cleaned and disinfected by wiping with solutions such as a 70% isopropyl alcohol, 2% glutaraldehyde, or 10% bleach solution. Wipe down with a water-dampened clean cloth to rinse. Dry before use.
- Do not immerse the monitor, BaseStation or external power supply.
- Do not attempt to sterilize the monitor, BaseStation or external power supply.

#### ***SpO<sub>2</sub> Finger Sensor***

- The sensor can be cleaned and disinfected by wiping with solutions such as a 70% isopropyl alcohol, 2% glutaraldehyde, or 10% bleach solution. Then wipe down with a water dampened clean cloth to rinse. Dry before use.
- Make certain that the finger sensor windows are clean and dry before reuse.
- Do not immerse the finger sensor.
- Do not attempt to sterilize the finger sensor.
- After cleaning the finger sensor, verify that the sensor is physically intact, with no broken or frayed wires or damaged parts. Make certain that the connectors are clean and dry, with no signs of contamination or corrosion. Do not use a broken or damaged sensor or one with wet, contaminated or corroded connectors.
- Perform a "Quick Check" to verify the integrity of the sensor (See "Finger Sensor Quick Check" on page 31).

#### ***SpO<sub>2</sub> Y-Sensor***

- Do not immerse connector on the Y-Sensor.
- The Y-Sensor may be immersed—up to, but not including, the connector, in a 2% glutaraldehyde solution, or 10% bleach solution. Refer to manufacturer's instructions and standard hospital protocols to determine recommended times for disinfection and sterilization.
- Rinse thoroughly with water and dry before use (do not rinse the connector).

- Do not attempt to sterilize Y-Sensor except as stated above.
- After cleaning or sterilizing the Y-Sensor, verify that the sensor is physically intact, with no broken or frayed wires or damaged parts. Make certain that the connectors are clean and dry, with no signs of contamination or corrosion. Do not use a broken or damaged sensor or one with wet, contaminated, or corroded connectors.
- Perform a “Quick Check” to verify the integrity of the sensor (See “Y-Sensor Quick Check” on page 34).

### ***SpO<sub>2</sub> Y-Strip Tapes and Foam Wraps***

- Treat Y-Strip Tapes and foam wraps in accordance with hospital protocol for single-patient use items.

### ***Ear Clip***

- Do not immerse the ear clip
- Clean the ear clip with a cloth dampened with 70% isopropyl alcohol. After cleaning wipe the ear clip down thoroughly with a clean water dampened cloth to rinse.

### ***CAPNOSTAT<sup>®</sup> CO<sub>2</sub> Sensor***

- Clean the sensor surface with a damp cloth.
- Make certain that the sensor windows are clean and dry.
- Do not immerse the CAPNOSTAT<sup>®</sup> CO<sub>2</sub> sensor.
- Do not attempt to sterilize the CAPNOSTAT<sup>®</sup> CO<sub>2</sub> sensor.

### ***Single Patient Use Airway Adapters***

- Treat all single patient use airway adapters in accordance with hospital protocol for single-patient use items.

### ***External Sampling System Components (Model 715)***

- The Nasal Sampling Cannulas and adapters are for single-patient use.







### Internal Sampling System Components (Model 715)

Acceptable fluids for cleaning and sterilizing the internal pneumatic parts of the Sampling System include isopropyl alcohol, Cidex<sup>®</sup> or equivalent, or a 5.25% water solution by weight of sodium hypochlorite (bleach).

#### CAUTION

Do not attempt to pump cleaning/sterilizing liquid with the sampling pump. This may cause accelerated wear on the pump bearings. Always flush liquids with a syringe as described in the following instructions.

#### To clean and disinfect the pumping system:

1. Turn the monitor off and disconnect the external power supply (if connected).
2. Remove both the sampling inlet tubing set and the sampling exhaust tubing (if any).
3. Attach an exhaust port line (1/8 inch or 3/16 inch I.D. tubing) from the Sampling Exhaust  port to a suitable container located below the bottom level of the monitor.
4. Use a 60 cc catheter tip syringe. Fit it to the Sampling Inlet  connector. Flush the sterilizing solution slowly through the pumping system. Push the entire 60 cc of solution through the Sampling Inlet . Repeat this process two more times to use a total of 180 cc of solution.
5. Remove the syringe and leave the cleaning/sterilizing fluid within the sampling pump system for 30 minutes to disinfect the system. Follow sterilant manufacturer's instructions for disinfection.
6. After 30 minutes, fill the syringe with distilled water and flush the system three times. Allow the cleaning/disinfection solution and distilled water to drain through the Sampling Exhaust  output.
7. Push several syringes of air slowly through the system to ensure that most of the liquid has been drained.
8. Follow this with at least three more syringes of distilled water, followed by at least two more syringes of air to make sure that most of the distilled water has been drained.
9. Remove the syringe from the unit. Do not connect the sampling inlet tubing. Connect the external power supply and turn the monitor on. Allow the sampling pump to operate for several minutes. This will help to remove any trapped water.
10. Connect a sampling tubing set to the Sampling Inlet .
11. Block the open end of the tubing with your finger. Alternate blocking and unblocking the tubing end at least ten times. Use a quick, brisk motion when blocking and unblocking the tubing. Keep the tubing blocked and unblocked for several seconds at a time.
12. Repeat the same blocking and unblocking action with your finger on the sampling exhaust  port.
13. Allow the sampling system to run for at least 30 minutes without the sampling assembly tubing and the sampling exhaust tubing connected. This will speed dry the system pneumatics.
14. Once these cleaning and disinfection instructions have been completed, normal sampling system operation can be resumed. See "Sidestream Sampling (Model 715)" on page 27 for more information.

## Battery Maintenance

---

If the monitor has not been used or powered by the external power supply for an extended time<sup>6</sup> (3 months or more) allow the battery to charge before use or replace the battery with a fully charged battery and continue monitoring. The monitor may not power up on battery power if the battery is not sufficiently charged. Refer to “Battery Life and Recharge Times” on page 16 for charging times and instructions.

## Maintenance Schedules

---

When the monitor powers up, a self-test is performed which checks the internal electronics of the monitor. If this self-test fails, remove the monitor from use and contact qualified service personnel.

The monitor should undergo routine inspection and safety checks on a quarterly basis or according to hospital protocol. The *TIDAL WAVE<sup>®</sup> Sp* Service Manual (Catalog No. 9110-90/9146-90) contains procedures and safety test instructions, component parts lists, circuit diagrams, theory of operation and other information to assist qualified service personnel in servicing the monitor.

## WEEE/RoHS Recycling Directives

---

Waste electrical and electronic equipment and restriction of the use of certain hazardous substances in electrical and electronic equipment (WEEE/RoHS) recycling directives.



Compliant with the WEEE/RoHS recycling directives.

If you are subject to the WEEE/RoHS directives, refer to [www.respironics.com](http://www.respironics.com) for the passport for recycling this product.

---

<sup>6</sup>The internal battery will slowly discharge over long periods of non-use.

## Section 8

## Specifications

---

### General

---

Specifications for the *TIDAL WAVE*<sup>®</sup> Sp Monitor, Model 710/715, are listed for informational purposes only, and are subject to change without notice.

### Capnograph

---

- Principle of Operation: Non-Dispersive Infrared (NDIR) absorption, dual wavelength ratiometric-single beam optics
- Sensor Type: "Mainstream" (no gas sample drawn from breathing circuit)
- Initialization Time: Capnogram in 15 seconds, full specifications in 60 seconds.
- Response Time: 60 ms
- Gas Compensation - Room Air, O<sub>2</sub> > 60%, N<sub>2</sub>O > 60%: Operator selectable in configuration screen.
- Barometric Pressure Compensation: Automatic (range 400-800 mmHg)
- CAPNOSTAT<sup>®</sup> CO<sub>2</sub> Sensor and Airway Adapter:
  - Weight: Less than 18 g without cable
  - Sensor Size: 1.3 x 1.67 x .85 inches (3.30 x 4.24 x 2.16 cm), 6 foot cable (1.83 m)
  - Construction: Durable high performance plastic, ultra-flexible cable
  - Shock Resistant: CAPNOSTAT<sup>®</sup> CO<sub>2</sub> sensor withstands a 6 foot drop to a tile floor
- Airway Adapter: Single Patient Use, less than 5 cc deadspace, meets ANSI Z-79

### EtCO<sub>2</sub> Section (Mainstream)

- Range 0-150 mmHg, CO<sub>2</sub> partial pressure
- Accuracy<sup>†</sup>: 0-40 mmHg ±2 mmHg, 41-70 mmHg 5% of reading, 70-150 mmHg ±8% of reading.
- Warm-up Time: Operational in 15 seconds, 1 minute to full specifications
- Step Response Time: 60 ms, adult; less than 50 ms, neonate
- Averaging Time: 1 breath, 10 seconds (default), 20 seconds, instantaneous
- Display Resolution: 0-25, 0-50, and 0-150 mmHg in 31 pixels
- Alerts: User selectable alert limits for EtCO<sub>2</sub>.

---

<sup>†</sup>Allows for halogenated anesthetic agents which may be present at normal clinical levels. The presence of desflurane in the exhaled breath beyond normal levels (5-6%) may positively bias carbon dioxide values by up to an additional 2-3 mmHg.

**Respiratory Rate (Mainstream)**

- Range 0-150 breaths/min.
- Accuracy:  $\pm 1$  breaths/min.
- Alerts: The Model 710/715 has user selectable alert limits for Respiratory Rate.
- Averaging Time: 8 seconds

**EtCO<sub>2</sub> Section (Sidestream)**

- Range 0-150 mmHg, CO<sub>2</sub> partial pressure
- Accuracy<sup>\*\*</sup>: 0-40 mmHg  $\pm 2$  mmHg, 41-70 mmHg 5% of reading, 70-150 mmHg  $\pm 8\%$  of reading.
- Delay Time<sup>\*\*\*</sup>: < 2 seconds
- Warm-up Time: Operational in 15 seconds, 1 minute to full specifications
- Step Response Time: less than 200 ms; Sampling Rate - 180 cc/min.
- Averaging Time: 1 breath, 10 seconds (default), 20 seconds, instantaneous
- Display Resolution: 0-25, 0-50, and 0-150 mmHg in 31 pixels
- Alerts: The Model 715 has user selectable alert limits for EtCO<sub>2</sub>.

**Respiratory Rate (Sidestream, Model 715)**

- Range 0-70 breaths/min
- Accuracy:  $\pm 1$  breaths/min.
- Alerts: The Model 715 has user selectable alert limits for Respiratory Rate.
- Averaging Time: 8 seconds

**SpO<sub>2</sub> Section**

- Range 0-100%
- Accuracy: 70-100%  $\pm 2\%$  SpO<sub>2</sub>;  $\pm 1$  standard deviation; 0-69% unspecified. Applies to Finger Sensor, Y-Sensor®, and Single Patient Use (SPU) sensors. Applies to all locations except the earclip, which can add an additional 1%.
- Display Resolution: 1%
- Averaging Time: menu-selectable times of 2 and 8 seconds (default is 8 seconds)
- Audible SpO<sub>2</sub> Trend Feature: Pitch of (user selectable) pulse rate “beep” tracks the SpO<sub>2</sub> values (i.e. decreasing SpO<sub>2</sub> values are signaled by lower pitched “beeps”).
- Settling Time: Display settles to within 1% of final reading less than 15 seconds after the sensor is properly applied.
- Alerts: The Model 710/715 will have user selectable alert limits for SpO<sub>2</sub>.

<sup>\*\*</sup>Allows for halogenated anesthetic agents which may be present at normal clinical levels. The presence of desflurane in the exhaled breath beyond normal levels (5-6%) may positively bias carbon dioxide values by up to an additional 2-3 mmHg. Maintained up to 70 breaths/minute.

<sup>\*\*\*</sup>With 10 foot sample line. Delay time will be increased with longer sample lines (< 0.2 seconds/foot of sample line).



## Pulse Rate Section

---

- Range: 30-250 beats per minute (bpm)
- Accuracy: (1 standard deviation), 1% of full scale
- Display Resolution: 1 bpm
- Averaging Time: menu-selectable times of 2 and 8 seconds (default is 8 seconds)
- Settling Time: Display settles to within 1% of final reading less than 15 seconds after the sensor is properly applied.
- Alerts: The Model 710/715 will have user selectable alert limits for Pulse Rate.



## Monitor Specifications

---

- Classification (IEC60601-1): Class I, internally powered, type BF, enclosure protection rating of IPX1<sup>\*\*\*\*</sup>. Operating Environment: 50 to 104° F (10 to 40° C), 0-90% relative humidity (non-condensing)
- Transport/Storage:  
short term: 14° to 122° F (-10 to 50° C) with NiMH battery  
long term: 14° to 95° F (-10 to 35° C) with NiMH battery  
storage: 14° to 131° F (-10° to 55° C) without NiMH battery
- Size: 7.9" x 3.25" x 1.5"
- Weight: 24 ounces
- Power: 100-250 VAC, .38A, 50-60 Hz
- Battery: Rechargeable DR30 NiMH battery pack (Cat. No. 400043) or equivalent; AA lithium batteries - Energizer L91 or equivalent.
- Battery Life: Approximately 4.5 hours of continuous use with fully charged DR30 NiMH rechargeable battery pack. Approximately 4.0 hours with sample pump in operation.
- Display: LED backlit 2.5" x 1.25" LCD, adjustable contrast
- LED indicators for: Low battery, adapter type, audio/alert status (indicates audio off, 2 minute suspend, active alert), and external power.
- Electromagnetic Emissions: Conforms to Medical Device Directive 93/42/EEC, IEC60601-1-2 (2001), CISPR11 (1991), IEC61000-3-2 (2001), IEC61000-3-3 (2003)
- Electromagnetic Immunity: Conforms to Medical Device Directive 93/42/EEC, IEC60601-1-2 (2001), IEC61000-4-2 (1995), IEC61000-4-3 (2002), IEC61000-4-4 (2004), IEC61000-4-5 (1995), IEC61000-4-6 (2003), IEC61000-4-8 (1994), IEC61000-4-11 (2004)



## Additional Features

---

- Audible SpO<sub>2</sub> Trend Feature: Pitch of Pulse Rate "beep" tracks the SpO<sub>2</sub> value, user selectable volume.
- Alert Limits: Automatic or menu selected high and low limits for ET/CO<sub>2</sub>, Respiratory Rate, SpO<sub>2</sub> and Pulse Rate, NO RESPIRATION alert selectable between 20, 40 and 60 seconds. Visible and audible alerts are immediate.
- 2-Minute Suspend: When  key is pressed, audible alerts are suspended for two minutes. Indicated by yellow 2 minute LED and flashing  bell icon

---

<sup>\*\*\*\*</sup>External power supply excluded.

- Audio Off: Press and hold  key for 3 seconds to deactivate audible alerts. Indicated by flashing yellow Audio Off LED and flashing  bell icon.
- Trend Memory: 24 hour trend memory capacity, battery backed. On-screen 30 minute trends for ETCO<sub>2</sub>, Respiration Rate and SpO<sub>2</sub>. Other parameters are stored internally and can be downloaded to a PC.
- Digital Data Output: Serial (RS232), connect only to Respirationics approved devices.
- Sampling System (Model 715): Standard. Allows gas sampling of non-intubated patients
- Internal Battery-backed Real Time Clock

## Section 9

## Accessories

TIDAL WAVE<sup>®</sup> Sp (Model 710/715)

Capnography/Oximetry Monitor

Catalog No. Description

### CO<sub>2</sub> AIRWAY ADAPTERS, SINGLE-PATIENT USE

- 6063-00 **Single-Patient Use Adult Airway Adapters** (10 per box) 2 or more boxes
- 6421-00 **Single-Patient Use Adult Airway Adapters** with mouthpiece (10 per box) 2 or more boxes
- 6312-00 **Single-Patient Use Neonatal Airway Adapters** (10 per box) 2 or more boxes

### SIDESTREAM SAMPLING KITS AND ACCESSORIES, SINGLE-PATIENT USE

- 8954-00 **Single-Patient Use Sampling Adapter** (10 per box) 2 or more boxes
- 8955-00 **Single-Patient Use Sampling Adapter with Nasal CO<sub>2</sub> Sampling Cannula—Adult**  
(10 per box) 2 or more boxes
- 8956-00 **Single-Patient Use Sampling Adapter with Nasal CO<sub>2</sub> Sampling Cannula—Pediatric**  
(10 per box) 2 or more boxes
- 8957-00 **Single-Patient Use Sampling Adapter, Nasal CO<sub>2</sub> Sampling, O<sub>2</sub> Delivery Cannula—Adult** (10 per box) 2 or more boxes
- 8958-00 **Single-Patient Use Sampling Adapter, Nasal CO<sub>2</sub> Sampling, O<sub>2</sub> Delivery Cannula—Pediatric**  
(10/box) 2 or more boxes
- 9675-00 **Sidestream Sampling Kit** Includes Elbow, Airway Adapter, Filter and 10 ft. Sample Line (10 per bag)
- 9906-00 **Replacement Filters** for Sidestream Sampling Kit (50 per bag)
- 3121-00 **Sampling Tubing Kit** Used to connect Single Patient Use Sampling Adapter to monitor (10 per bag)

### CAPNO<sub>2</sub>mask™

- 9960PED-00 **CAPNO<sub>2</sub>mask™** - Pediatric O<sub>2</sub> Delivery/CO<sub>2</sub> Mainstream Monitoring Mask (10 per bag)
- 9960STD-00 **CAPNO<sub>2</sub>mask™** - Adult Standard O<sub>2</sub> Delivery/CO<sub>2</sub> Mainstream Monitoring Mask (10 per bag)
- 9960LGE-00 **CAPNO<sub>2</sub>mask™** - Adult Large O<sub>2</sub> Delivery/CO<sub>2</sub> Mainstream Monitoring Mask (10 per bag)

### SpO<sub>2</sub> SENSORS

- 9169-00 **Y-Sensor™** (use with DB-9 Sensors), 3 feet, 90 day warranty
- 9769-00 **Y-Sensor™** (use with DB-9 Sensors), 6 feet, 90 day warranty
- 9168-00 **Finger Sensor** (use with DB-9 Sensors), 3 feet, 1 yr. warranty
- 9768-00 **Finger Sensor** (use with DB-9 Sensors), 6 feet, 1 yr. warranty
- 6455-25 **Single Patient Use Pediatric/Adult Sensor** (25 per box)
- 6480-25 **Single Patient Use Neonatal/Pediatric Sensor** (25 per box)
- 9174-00 **Extension Cable**, DB-9 to DB-9, 4.5 feet
- 9175-00 **Extension Cable**, DB-9 to OxySnap™, 4.5 feet
- 8933-00 **Extension Cable**, Hypertronics to DB-9, 8 feet

## Section 9

Catalog No.	Description
9180-00	<b>Adapter Cable</b> , DB-9 to Hypertronics, 6 inch
<b>Y-SENSOR™ APPLICATORS</b>	
8828-00	<b>20mm Wrap Style Taping System</b> (100 per box) Use on neonatal foot and hand, or on pediatric toe or finger, color coded blue
8829-00	<b>25mm Wrap Style Taping System</b> (100 per box) Use on neonatal foot and hand, color coded green
8831-00	<b>20mm Finger Style Taping System</b> (100 per box) Use on pediatric finger or on small adult finger, color coded blue
8832-00	<b>25mm Finger Style Taping System</b> (100 per box) Use on adult finger, color coded green
6929-00	<b>Adhesive Foam Wraps</b> , Large (25 per box)
6968-00	<b>Adhesive Foam Wraps</b> , Small (25 per box)
8836-00	<b>Non-Adhesive Foam Wraps</b> , Large (25 per box)
8943-00	<b>Non-Adhesive Foam Wraps</b> , Small (25 per box)
6131-00	<b>Ear Clips</b> (10 per bag)
8700-00	<b>Adhesive Dots</b> (200 per box)
<b>ACCESSORIES</b>	
420025	<b>Tidal Wave® Inservice Video</b> (NTSC format)
315127	<b>Carrying Case</b>
6862-00	<b>Battery Holder</b> (holds 7 "AA" batteries)

## Section 10

## *Electromagnetic Compatibility*

---

---

Medical equipment needs special precautions regarding electromagnetic compatibility (EMC) and needs to be installed and put into service according to the EMC information provided in this document.

The Model 710/715 monitor complies with IEC 60601-1-2:2001, providing reasonable protection against electromagnetic interference in a typical medical installation. The equipment generates, uses and can radiate electromagnetic interference (EMI), and if not installed and used in accordance with the instructions, may cause interference with other devices in the vicinity.

If interference does occur, correct it using one or more of the following measures:

- Move the receiving device or increase separation between the equipment.
- Consult Respironics or members of the hospital's engineering department for more information.

### ***Warnings***

---

- The use of portable and mobile radio frequency (RF) communications equipment can affect this and other pieces of medical equipment.
- The use of accessories, sensors and cables other than those specified by Respironics may increase emissions or decrease immunity of the equipment.
- The Model 710/715 should not be used adjacent to or stacked with other equipment; if adjacent or stacked use is necessary, the equipment should be observed to verify normal operation in the configuration in which it will be used.

### ***Cautions***

---

- Observe precautions for electrostatic discharge (ESD) and electromagnetic interference (EMI) to and from other equipment.
- Where electromagnetic devices (i.e., electrocautery) are used, patient monitoring may be interrupted due to electromagnetic interference. Electromagnetic fields up to 3 V/m will not adversely affect system performance.
- Sudden erratic changes in equipment performance that do not correlate to the physiological condition of the patient may be signs that the monitor is experiencing electromagnetic interference.

## Electromagnetic Emissions

Guidance and manufacturer's declaration - Electromagnetic emissions		
The Model 710/715 is intended for use in the electromagnetic environment specified below. The customer or user of the Model 710/715 should assure that it is used in such an environment.		
Emissions Test	Compliance	Electromagnetic environment - guidance
RF emissions CISPR 11	Group 1	The Model 710/715 uses RF energy only for its internal function. Therefore, its RF emissions are very low and are not likely to cause any interference in nearby equipment.
RF emissions CISPR 11	Class A	Class A: The Model 710/715 is suitable for use in all establishments other than domestic and those directly connected to the public low-voltage power supply network that supplies buildings used for domestic purposes.
Harmonic emissions IEC 61000-3-2	Class A	
Voltage fluctuations/ flicker emissions IEC 61000-3-3	Complies	

## Electromagnetic Immunity

Guidance and manufacturer's declaration - Electromagnetic immunity			
The Model 710/715 is intended for use in the electromagnetic environment specified below. The customer or user of the Model 710/715 should assure that it is used in such an environment.			
Immunity Test	IEC 60601 test level	Compliance level	Electromagnetic environment - guidance
Electrostatic Discharge (ESD) IEC 61000-4-2	±6 kV contact ±8 kV air	±6 kV contact ±8 kV air	Floors should be wood, concrete or ceramic tile. If floors are covered with synthetic material, the relative humidity should be at least 30%.
Electrical fast transient/burst IEC 61000-4-4	±2 kV for power supply lines ±1 kV for input/output lines	±2 kV for power supply lines ±1 kV for input/output lines	Mains power quality should be that of a typical commercial or hospital environment.
Surge IEC 61000-4-5	±1 kV differential mode ±2 kV common mode	±1 kV differential mode ±2 kV common mode	Mains power quality should be that of a typical commercial or hospital environment.
Voltage dips, short interruptions and voltage variations on power supply input lines IEC 61000-4-11	<5% $U_T$ (>95% dip in $U_T$ ) for 0.5 cycle 40% $U_T$ (60% dip in $U_T$ ) for 5 cycle 70% $U_T$ (30% dip in $U_T$ ) for 25 cycles <5% $U_T$ (>95% dip in $U_T$ ) for 5 sec.	<5% $U_T$ (>95% dip in $U_T$ ) for 0.5 cycle 40% $U_T$ (60% dip in $U_T$ ) for 5 cycle 70% $U_T$ (30% dip in $U_T$ ) for 25 cycles <5% $U_T$ (>95% dip in $U_T$ ) for 5 sec.	Mains power quality should be that of a typical commercial or hospital environment. If the user of the Model 710/715 requires continued operation during power interruptions, it is recommended that the Model 710/715 be powered from an uninterruptible power supply or a battery.

Guidance and manufacturer's declaration - Electromagnetic immunity (Continued)			
Power frequency (50/60 Hz) magnetic field IEC 61000-4-8	3 A/m	3 A/m	Power frequency magnetic fields should be at levels characteristic of a typical location in a typical commercial or hospital environment.
NOTE: $U_T$ is the a.c. mains voltage prior to the application of the test level			

Guidance and manufacturer's declaration - Electromagnetic immunity			
The Model 710/715 is intended for use in the electromagnetic environment specified below. The customer or user of the Model 710/715 should assure that it is used in such an environment.			
Immunity Test	IEC 60601 test level	Compliance level	Electromagnetic environment - guidance
Conducted RF IEC 61000-4-6	3 Vrms 150 kHz to 80 MHz	3 Vrms 150 kHz to 80 MHz	Portable and mobile RF communications equipment should be used no closer to any part of the Model 710/715, including cables, than the recommended separation distance calculated from the equation applicable to the frequency of the transmitter.  Recommended separation distance:  $d = \left[ \frac{3.5}{f} \right] \sqrt{P}$  $d = \left[ \frac{3.5}{E} \right] \sqrt{P}$ 80 MHz to 800 MHz  $d = \left[ \frac{7}{E} \right] \sqrt{P}$ 800 MHz to 2.5 GHz  where $P$ is the maximum output power rating of the transmitter in watts (W) according to the transmitter manufacturer and $d$ is the recommended separation distance in meters (m).  Field strength from fixed RF transmitters, as determined by an electromagnetic site survey <sup>a</sup> , should be less than the compliance level in each frequency range. <sup>b</sup>  Interference may occur in the vicinity of equipment marked with the following symbol:  
Radiated RF IEC 61000-4-3	3 V/m 80 MHz to 2.5 GHz	3 V/m 80 MHz to 2.5 GHz	
NOTE 1: At 80 MHz and 800MHz, the higher frequency range applies.			
NOTE 2: These guidelines may not apply in all situations. Electromagnetic propagation is affected by absorption and reflection from structures, objects and people.			
a. Field strengths from transmitters, such as base stations for radio (cellular, cordless) telephones and land mobile radios, amateur radio, AM and FM radio broadcast and TV broadcast cannot be predicted theoretically with accuracy. To assess the electromagnetic environment due to fixed RF transmitters, an electromagnetic site survey should be considered. If the measured field strength in the location in which the Model 710/715 is used exceeds the applicable RF compliance level above, the equipment should be observed to verify normal operation. If abnormal operation is observed, additional measures may be necessary, such as reorienting or relocating the Model 710/715.			
b. Over the frequency range of 150 kHz to 80MHz, field strengths should be less than 3 V/m.			

<b>Recommended separation distances between portable and mobile RF communications equipment and the Model 710/715</b>			
The Model 710/715 is intended for use in the electromagnetic environment in which radiated RF disturbances are controlled. The customer or the user of the Model 710/715 can help prevent electromagnetic interference by maintaining a minimum distance between portable and mobile RF communications equipment (transmitters) and the Model 710/715 as recommended below, according to the maximum output power of the communications equipment.			
<b>Rated maximum output power of transmitter (Watts)</b>	<b>Separation distance according to the frequency of transmitter (meters)</b>		
	150 kHz to 80 MHz $d = \left[ \frac{3.5}{f} \right] \sqrt{P}$	80 MHz to 800 MHz $d = \left[ \frac{3.5}{f} \right] \sqrt{P}$	800 MHz to 2.5 GHz $d = \left[ \frac{7}{f} \right] \sqrt{P}$
0.01	0.12	0.12	0.23
0.1	0.37	0.37	0.74
1	1.2	1.2	2.3
10	3.7	3.7	7.4
100	12	12	23
For transmitters rated at a maximum output power not listed above, the recommended separation distance $d$ in meters (m) can be estimated by using the equation applicable to the frequency of the transmitter, where $P$ is the maximum power rating of the transmitter in watts (W) according to the transmitter manufacturer.			
NOTE 1: At 80 MHz and 800MHz, the separation distance for the higher frequency range applies.			
NOTE 2: These guidelines may not apply in all situations. Electromagnetic propagation is affected by absorption and reflection from structures, objects and people.			